

MKT 001 200 11



Porsche Cars North America, Inc.  
980 Hammond Drive, Suite 1000  
Atlanta, Georgia 30328



Dr. Ing. h.c. F. Porsche AG is the owner of numerous trademarks, both registered and unregistered, including without limitation the Porsche Crest®, Porsche®, Boxster®, Carrera®, Cayenne®, Cayman®, Panamera®, Speedster®, Spyder®, Tiptronic®, VarioCam®, PCM®, PDK®, 911®, 4S®, 918 Spyder™, FOUR, UNCOMPROMISED.®, and other model names and numbers, and the distinctive shapes of the Porsche automobiles, such as the federally registered 911 and Boxster automobiles. The third-party trademarks contained herein are the properties of their respective owners. Porsche Cars North America, Inc., believes the specifications to be correct at the time of printing. Specifications, performance standards, standard equipment, options, and other elements shown are subject to change without notice. Some options may be unavailable when a car is built. Some vehicles may be shown with non-U.S. equipment. Please ask your dealer for advice concerning the current availability of options and verify the optional equipment that you ordered. Porsche recommends seat-belt usage and observance of traffic laws at all times.

All fuel consumption and emissions data contained herein are derived from U.S. tests and were accurate at time of press.

©2011 Porsche Cars North America, Inc. Printed in the U.S.A. MKT 001 200 11 porscheusa.com 1-800-PORSCHE

The Cayman

The Cayman



# Contents

■ The Cayman	2	■ Personalization	100
■ The models	20	■ Porsche Exclusive	118
■ Drive	26	■ Porsche Tourist Delivery	119
■ Chassis	50	■ Service	120
■ Safety	60	■ Summary	122
■ Comfort	72	■ Technical data	124
■ Environment	94	■ Index	126



# The Cayman

**Distinctive. Unyielding. Resolute. Strong-willed.  
The perfect match.**

Do you go your own way? Do you stop to question the rules, and prefer to make your own? Would you rather trust your own mind than go with the flow?

Then this is the place for you. Right here in the driver seat.

The Cayman and the Cayman S. An uncompromising declaration of individuality.

Convention shaken.  
Senses stirred.

The Cayman models.



Two different characters. One personality. Their drive for power is impressive, their spirited nature fascinating. Two sport coupes that go beyond all conventions. Two cars that draw their drivers under their spell, forever.

The concept behind the Cayman models is the “Le Mans Coupe,” a sport coupe designed in 1953 specifically for this legendary race and based on the 550 Spyder. Its mid-engine layout is what made this car special. The car’s low center of gravity gave it tremendous agility and cornering dynamics. From this one basic idea came great success, and with this success our experience grew. The result? Two sophisticated sports cars. The Cayman and the Cayman S.

Their uncompromising performance is generated by two engine developments,

which stand out above all for their lightweight construction, power output, and efficiency. The Cayman has a 2.9-liter flat-six engine with a power output of 265 horsepower.

Even more impressive are the performance values of the Cayman S with Direct Fuel Injection (DFI). The air/fuel mixture is prepared entirely in the combustion chamber after having been metered and injected directly, with millisecond precision. This means even more power and torque. To express this in figures, its 3.4-liter flat-six engine unleashes a mighty 320 horsepower in an efficient manner—29 mpg on the highway with the optional PDK.

In either model, this tremendous power is delivered to the road by a precision six-speed manual gearbox. Porsche Doppelkupplung (PDK) is available as an option. The key

elements of PDK are its seven gears, two half gearboxes, and two clutches. It features both manual and automatic modes. Gears are changed using the gear selector for PDK, the switches on the three-spoke sport steering wheel, or the new, optional three-spoke sport steering wheel with gearshift paddles. The gear change takes place in a matter of milliseconds without any interruption in the flow of power. The advantage over a fully manual transmission is the considerably faster rate of acceleration and a slightly improved fuel consumption. The advantage over a fully automatic transmission is the perceptible increase in driving dynamics—with a similar level of comfort, and a distinct reduction in fuel consumption.



Cayman S in Carrara White

The handling of the Cayman models is impressive. The tuning of the chassis is undoubtedly sporty, with no compromise in the comfort required for longer journeys.

For a driving experience that is even more involving, consider the optionally available Sport Chrono Package. It offers even sportier tuning of the

engine and chassis at the push of a button. The optional mechanically locking rear differential delivers high traction and increased performance.

A wider track and generously dimensioned wheels are also your guarantee of a resolutely dynamic driving experience.

The headlight design and LED taillights are a striking feature.

Bi-Xenon™ headlights including LED daytime running lights and dynamic cornering lights are available as an option.

Fitted as standard, the Porsche Stability Management (PSM) system combines a range of safety functions, such as precharging of the brake system, and Brake Assist.



Cayman in Basalt Black Metallic

A high level of passive safety is provided by the driver and passenger airbags, which are fitted as standard, and the Porsche Side Impact Protection (POSIP) system with head and thorax airbags.

A look inside the passenger compartment leaves you with no doubt that the car was designed for uncompromising sportiness.

All the important functions are intuitive to control, including the optional Porsche Communication Management (PCM) with navigation module, 6.5-inch touchscreen, and CD/DVD drive. Optional seat ventilation keeps you cool when the weather is very warm, while the heated steering wheel is a welcome feature on particularly cold days. The optionally available

Bose® Surround Sound system offers a genuine alternative to the distinctive sound of the engine. In conjunction with PCM, it supports audio playback of audio and video DVDs in the 5.1 digital surround format.

In fact, there remains only one thing to consider: Which one suits you best?







Front design (Cayman S)



Rear design (Cayman)

**An unmistakable style.**

**Design.**

The design of the Cayman models is befitting of their distinctive, sporty character.

Their performance potential is obvious at first sight, for these are true specimens of

force and athleticism. Individual styling features help to define both vehicles so impressively.

A constant interaction of convex and concave curves. A certain style, like no other.

Immediately, the front displays the kind of character that you expect to find in the Cayman

models. The front end features large air intakes, the geometry of which is unmistakable.



Front design (Cayman)

The contouring of the front of the Cayman gives the car an extremely purposeful appearance. The front spoiler lip reduces lift at the front axle.

The front fenders with their integrated headlights give

the Cayman models a distinctively sporty look.

The headlights feature an imposing design. Both models are equipped as standard with halogen headlights, LED position lights, and fog lights integrated into the outer air

intakes. Bi-Xenon™ headlights with dynamic cornering lights, including LED daytime running lights, are available on request.

Follow the car's clean lines along the side toward the rear, and the impressive design continues. The styling is emphasized



Rear design (Cayman S)

by the distinctly pronounced curves of the front and rear hips and the shape of the doors.

Typical for a coupe, there is a gradual, flowing transition from the A-pillar to the rear. The sharper contour of the side skirts directs the airstream

down to the side air intakes, which are designed to facilitate considerable through-flow. The rear section of the side windows curves dynamically upward. Extending beyond the side windows are two additional lines that direct attention toward the rear end.

One of these lines continues to frame the large rear window.





Rear hip (Cayman S)

The second line continues its rearward path to the LED taillight module. The elegant, extendable rear spoiler further reduces lift at the rear axle.

Below, you cannot miss the visible hallmark of the characteristic Porsche sound: the stainless steel tailpipe—twin tailpipes on the Cayman S—integrated into the rear end.

The unmistakable styling of the Cayman models is complemented by the wheel design. The Cayman is fitted with 17-inch wheels as standard, the Cayman S with



Rear spoiler (Cayman), extended

18-inch wheels. A 19-inch option is available for both models. The result of all these measures? An impressive appearance and refined aerodynamics with a

drag coefficient of only 0.29. This is the principle of Porsche Intelligent Performance.

The Cayman models. Powerful and dynamic, and when it comes to style, they believe in only one direction: their own.



## The models

**Two models.  
One undeniable spirit.**

It's not just about the drive for individuality or supreme performance. Above all, it's the indescribable intensity with which the Cayman models express these two virtues.

Uncompromising. Unyielding. Completely unimpressible, but extremely impressive.



**The truth is in the driving.  
The Cayman.**

The Cayman is the driving force behind precisely one attitude: the absolute conviction to remain true to oneself. No middle roads. No compromises. No nonsense.

One of the features that exemplifies this attitude is the mid-engine layout, which ensures

a low center of gravity and thus a high degree of agility and an extremely sporty drive. The six-cylinder horizontally opposed power unit has a capacity of 2.9 liters. The engine delivers a power output of 265 horsepower at an engine speed of 7200 rpm. A maximum torque of 221 lb.-ft.

is achieved between 4400 and 6000 rpm. From a standing start, the Cayman accelerates to 60 mph in 5.5 seconds. With the optional Porsche Doppelkupplung (PDK), this sprint takes just 5.4 seconds. Top track speed is 164 mph in conjunction with the manual gearbox. The power

of the engine is delivered to the road by a precision six-speed manual gearbox. Fitted as standard are 17-inch wheels with a star-shaped design, which allows an eye-catching view of the powerful brake system. And the interior? The overall impression is simply one of

high quality. For instance, the rims of all available steering wheels are covered in Smooth-Finish Leather. The center console, finished in traditional black, is equipped as standard with the CDR-30 audio system with five-inch display. An

integrated six-disc CD changer is available as an option.

The Cayman has found its way. Without doubt.



## Freedom.

### The Cayman S.

To accept no compromises, to make conscious decisions, to be governed by nothing other than one's own free will, and to have a clear point of view. A highly promising way to build a sports car. For us, it's the only way.

This philosophy was also the basis for the development of the mid-mounted engine with a 3.4-liter capacity and Direct Fuel Injection (DFI). The engine delivers a power output of 320 horsepower at 7200 rpm, and

a maximum torque of 273 lb.-ft. is achieved at 4750 rpm.

The Cayman S reaches 60 mph in just 4.9 seconds. Top track speed isn't reached until 172 mph. Porsche Doppelkupplung (PDK) is available as an option.



With the optional Sport Chrono Package, 0–60 mph is achieved in 4.6 seconds.

In addition to having a higher power output, the Cayman S also differs from the Cayman in its appearance. It has a front spoiler painted in the vehicle's exterior color, and twin tailpipes in stainless steel. The sound? Distinctive. In keeping with the rest of the Cayman S.

But so much power also needs to be tamed. This is the task of the enlarged brake system with four-piston, aluminum monobloc fixed calipers in a striking red-painted finish.

To deliver the increased power output to the road, the Cayman S is fitted with 18-inch Cayman S II wheels. Their design exudes pure dynamism—as befits the model's overall look.

The Cayman S—more than just a sports car. It's a Porsche.



## Drive

**Uncompromising in their intent.  
Unwavering in their intensity.**

Two engines, several goals: high power, excellent driving dynamics, and comparatively low fuel consumption and CO<sub>2</sub> emissions. The engine is positioned in the middle of the car, 11.8 inches (30 cm) behind

the driver and just inches above the road. Any contact with the accelerator pedal unleashes power that knows only one direction: forward. And a sound that is second to none.

Two examples of the uncompromising efforts of our engineers.  
Going forward.

The engines of the Cayman models.

The flat-six engines.

The mid-mounted engines of both Cayman models are compact and lightweight, and the layout is familiar: six horizontally opposed cylinders.

The 2.9-liter engine of the Cayman delivers 265 horsepower at an engine speed of 7200 rpm. The maximum torque of 221 lb.-ft. is achieved between 4400 and 6000 rpm. The engine of the Cayman S features Direct Fuel

Injection (DFI) and has a larger capacity of 3.4 liters. Power output is 320 horsepower at 7200 rpm. Maximum torque: 273 lb.-ft. at 4750 rpm.

Each of the engines convinces with its outstanding performance figures, extremely smooth running, optimized gas cycles, and tremendous cornering agility. All of this is achieved by DFI (in the Cayman S), a lightweight construction, and

a host of other engineering advancements, e.g., VarioCam Plus. This system increases torque in the lower engine-speed range and power output in the upper engine-speed range. Injection and ignition are controlled by the

engine electronics. The driver regulates engine power—and of course sound—using the extremely precise electronic accelerator pedal.



3.4-liter flat-six engine of the Cayman S

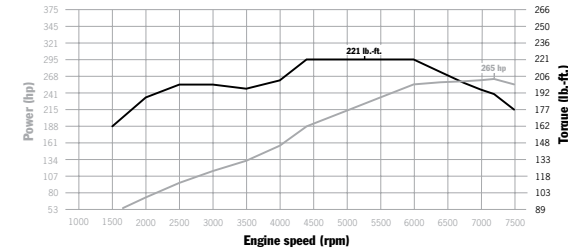

Cayman: 221 lb.-ft. between 4400 and 6000 rpm, 265 horsepower at 7200 rpm

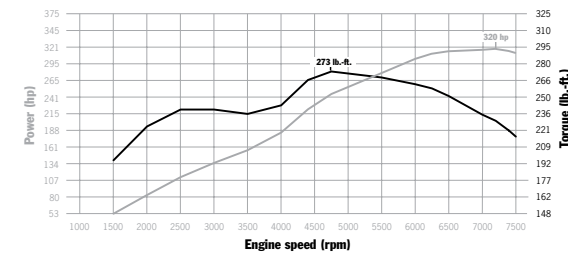

Cayman S: 273 lb.-ft. at 4750 rpm, 320 horsepower at 7200 rpm



Cayman S

### **Direct Fuel Injection (DFI).**

The engine of the Cayman S has Direct Fuel Injection (DFI). With millisecond precision, fuel is injected at up to 1,740 psi

(120 bar) directly into the combustion chamber by means of electromagnetically actuated injection valves.

The spray and cone angles have been optimized for torque,

power output, fuel consumption, and emissions by enabling a homogeneous distribution of the air/fuel mixture and, therefore, effective combustion. Multiple fuel injections take place, depending on the driving style.

DFI improves the internal cooling of the combustion chamber by having the mixture prepared directly in the cylinder. This allows for a higher compression ratio (12.5:1), which helps to deliver more output along with enhanced engine efficiency.

Injection is regulated by the electronic engine management system. The exhaust gas cleaning system ensures that emissions remain well below U.S. emissions standards, thus helping to protect the environment.

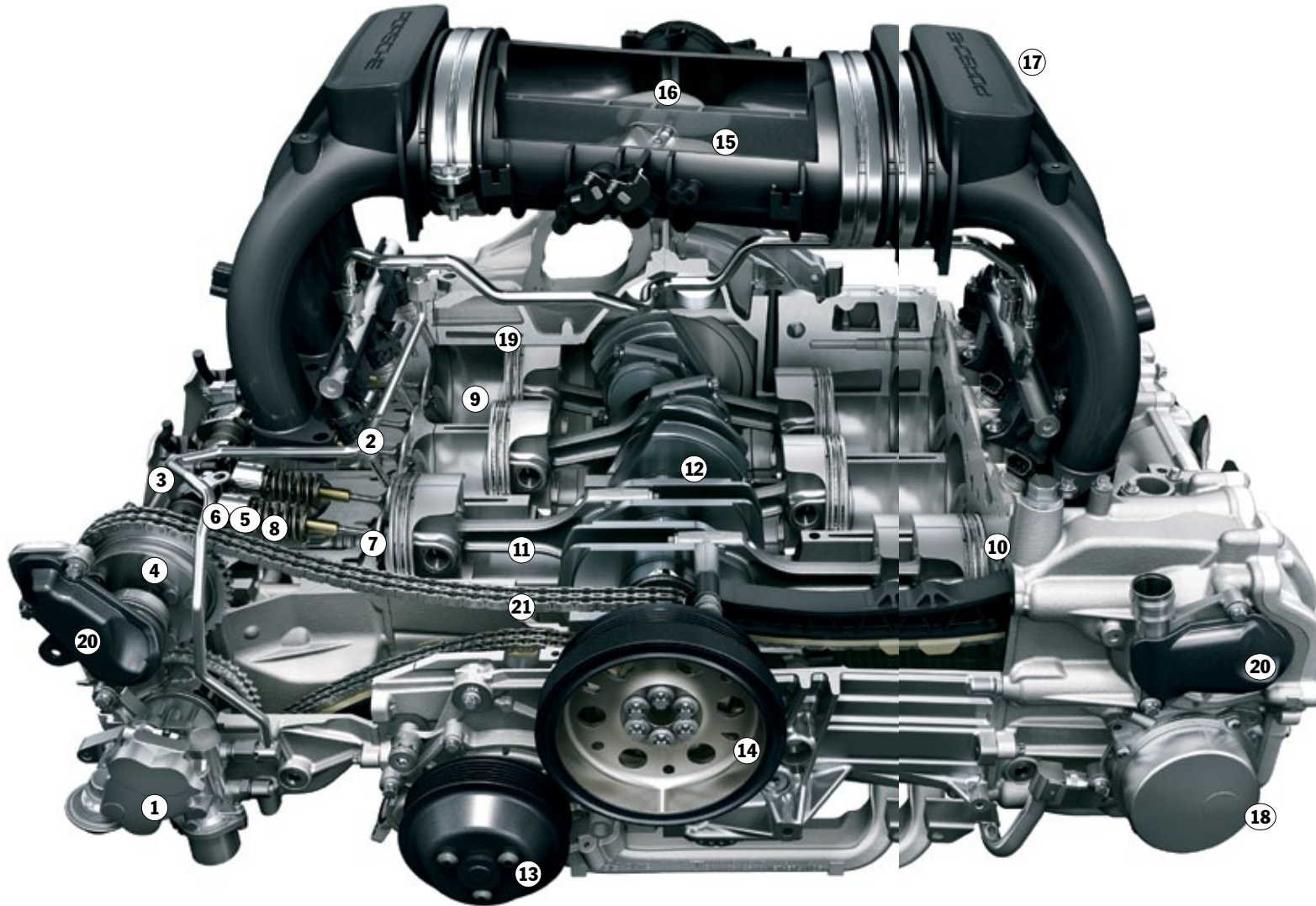

1. High-pressure pump
2. High-pressure injector
3. Ignition rod module
4. Camshaft controller
5. Switch tappet with integrated valve-clearance compensation
6. Intake camshaft
7. Intake valves
8. Valve spring
9. Combustion chamber with Alusil cylinder liner surface
10. Forged aluminum piston
11. Forged connecting rod
12. Crankshaft
13. Water pump
14. Vibration damper
15. Resonance valve
16. Distribution pipe flap
17. Intake manifold with integrated sound chamber
18. Vacuum pump
19. Coolant jacket
20. Crankcase breather
21. Timing chain

3.4-liter flat-six engine of the Cayman S





Cayman

### **Lightweight construction.**

Both Cayman models are equipped with alloy engines. The ingenious design, down to the finest detail, keeps the weight of the engines low, therefore reducing fuel consumption. One of the ways in which this

lightweight construction was achieved was by fully integrating the camshaft bearings into the cylinder heads.

### **Integrated dry-sump lubrication.**

The purpose of integrated dry-sump lubrication is to guarantee a reliable oil supply while reducing engine temperatures, even in sportily driven cars. The oil reservoir is located

inside the engine. Four oil pumps remove the oil from the cylinder heads directly into the oil sump. A fifth pump in the oil sump directly supplies the lubricating points in the engine.

To reduce power loss and increase efficiency, an

electronically controlled oil pump supplies the lubricating points inside the engine as and when required. This means that the oil pump does not work so hard when there is less demand for lubrication. For the engine, these detailed solutions mean a consistent

supply of oil, regardless of gravitational loads, even in the most demanding situations.



Cayman

**Engine cooling system.**

Our cross-flow cooling system, as used in motorsport, supplies each engine cylinder uniformly with coolant. Valves are thus protected against overload and premature wear, which minimizes the engine's tendency to knock and optimizes emissions and fuel consumption.

**Engine management system with E-gas.**

The electronic engine management system ensures optimal engine performance at all times. It regulates all engine-related functions and assemblies (see diagram). The results: optimal performance and torque with reduced fuel consumption and emissions.

Another important function of the system is cylinder-specific knock control. Since the six

cylinders never all work under exactly the same conditions, they are monitored individually by the knock control. The ignition point is shifted individually, as and when necessary, to protect the cylinders and pistons at high engine speeds. The onboard diagnostics ensure timely detection of any faults and defects that may occur in the exhaust and fuel systems, and notify the driver immediately. This also prevents increased pollutant emissions and unnecessary fuel consumption.

**Input data**

- Engine speed (from crankshaft)
- Inlet camshaft phase angle
- Engine load
- Throttle-valve angle
- Lambda Sensor® signals
- Knock sensor signals
- Temperatures
  - Coolant
  - Intake air
  - Air in engine compartment
  - Engine oil
  - Ambient air
- Pressures
  - Engine oil
  - Fuel
  - Ambient air
- Vehicle speed
- Air-conditioning settings
- Accelerator pedal

**Electronic engine management**  
ME 7.8/Cayman – SDI 3.1/Cayman S

**Regulation/control of**

- Ignition
- Manifold injection (Cayman)/ Direct Fuel Injection (Cayman S)
- Idling via throttle valve and ignition
- Heating of Lambda Sensors®
- Fuel pump (Cayman)/fuel pumps controlled on demand (Cayman S)
- Fuel-tank venting
- Camshaft position
- Valve-lift switchover (VarioCam Plus)
- Secondary air injection (Cayman)
- Engine fan
- Starter
- Continuously variable oil pump
- Fuel pressure (Cayman S)
- Throttle valve

CAN interface with driving dynamics control, transmission control, immobilizer, instrument cluster, climate control, Sport button, Sport Plus button, sport exhaust system button, diagnostics, etc.



Cayman S

### Two-stage resonance intake manifold.

The intake manifold with double-flow distributor pipe has an adjustable flap that closes and opens at defined engine speeds. As a result of a two-stage resonance effect, the air mass in the intake manifold begins to oscillate, which in turn generates a turbocharging effect and optimizes induction. These two effects combine to produce higher torque at low engine speeds, a flatter torque curve, and increased power output at high engine speeds, while the acoustic properties of the system are second to none. A sound that is typically Porsche.

### VarioCam Plus.

VarioCam Plus combines variable-valve timing with two-stage lift on the inlet side. This results in smoother running, better fuel economy, and lower exhaust emissions. As well as greater top-end power and low-end torque.

This two-in-one engine concept seamlessly adapts in response to driver input. The result: instant acceleration and extremely smooth running.

The variation in intake timing is steplessly controlled by means of an electrohydraulic rotary vane adjuster at the head of the corresponding camshaft.

To improve throttle response during the warm-up phase, VarioCam Plus selects high valve lifts with retarded valve timing. In the middle and low load ranges, low valve lifts with advanced timing reduce fuel consumption and exhaust emissions. High valve lifts generate high torque and maximum output.

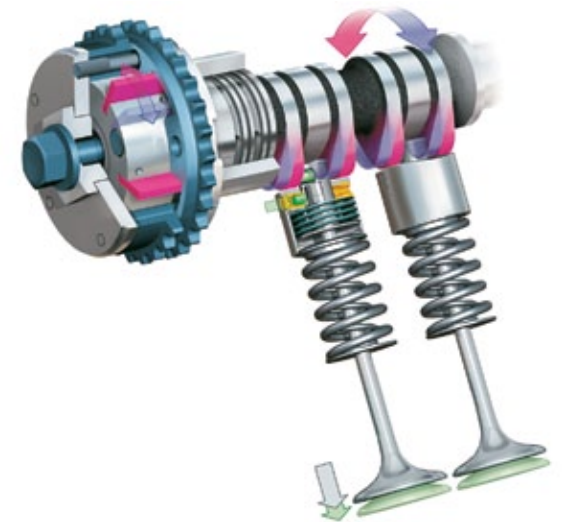

VarioCam Plus



Cayman S exhaust system



Cayman tailpipe



Cayman S twin tailpipes



Cayman S

### Ignition system.

The ignition system is designed for static high-voltage distribution. Individual ignition coils on each of the spark plugs ensure perfect ignition every time. The individual ignition coils are controlled directly by the engine electronics.

### Exhaust system.

The exhaust system—with twin tailpipes on the Cayman S—is made of stainless steel. Until it converges in the connecting tube, the exhaust gas is channeled through two separate tracts and, thanks to separate exhaust gas cleaning systems, the exhaust gas can flow more freely—for increased power and torque. The stereo Lambda

circuitry controls and monitors each cylinder bank separately. For each exhaust tract, four corresponding oxygen sensors regulate the composition of the exhaust gas and monitor the conversion of pollutants in the catalytic converters.

A sport exhaust system—for a more resonant sound—is available as an option for each of the Cayman models.

### Servicing.

It is a good idea to have your vehicle serviced regularly, but it makes just as much sense to keep the time between maintenance services as long as possible. Why? Because a Porsche belongs on the road, not in the workshop.

The alternator, power-steering pump, and the air-conditioning compressor are all driven by a single self-adjusting belt. Hydraulic valve-clearance compensation makes valve-clearance adjustment unnecessary. The drive chains on the camshafts do not normally require servicing. With the sole exception of the spark plugs, the ignition system is also maintenance-free.

Put simply, we don't expect to see your Porsche too often.



- |  |  |                                 |
|--|--|---------------------------------|
| <b>1. Radiator module</b>  | <b>6. Resonance intake manifold</b>                | <b>11. Interconnecting tube</b> |
| <b>2. Brake booster</b>  | <b>7. Coolant expansion tank</b>                   | <b>12. Oil-filler pipe</b>      |
| <b>3. Gear lever/gear selector</b>                                       | <b>8. Electronically controlled throttle valve</b> | <b>13. Air cleaner snorkel</b>  |
| <b>4. PASM shock absorbers</b>   | <b>9. Connecting duct</b>                          |                                 |
| <b>5. 6-speed manual gearbox or 7-speed Porsche Doppelkupplung (PDK)</b> | <b>10. Rear silencer</b>                           |                                 |

The transfer of power has never been more fluid.  
Or more seductive.

### Transmission.

#### Porsche Doppelkupplung (PDK).

The optional Porsche Doppelkupplung (PDK), with both manual gearshift and an automatic mode, enables smooth gear changes with no interruption in the flow of power. This results in significantly faster acceleration and lower fuel consumption, without having to sacrifice the ease of automatic transmission.

In total, PDK has seven gears at its disposal. Gears 1–6 have a sport ratio, and top speed is reached in 6th gear. The 7th gear has a long ratio and helps to reduce fuel consumption even further.

PDK is essentially two half gearboxes in one and thus requires two clutches—designed as a double wet-clutch transmission.

This double clutch provides an alternating, non-positive connection between the two half gearboxes and the engine by means of two separate input shafts (input shaft 1 is nested inside hollowed-out input shaft 2).

The flow of power from the engine is only ever transmitted through one half gearbox and one clutch at a time, while the

next gear is preselected in the second half gearbox. During a gear change, therefore, a conventional shift no longer takes place. Instead, one clutch simply opens and the other closes at the same time. Gear changes can therefore take place within milliseconds.

Clutch 1 controls the first half gearbox, which contains the odd gears (1, 3, 5, 7) and Reverse. Clutch 2 controls the second, which contains the even gears (2, 4, 6).



Cayman S



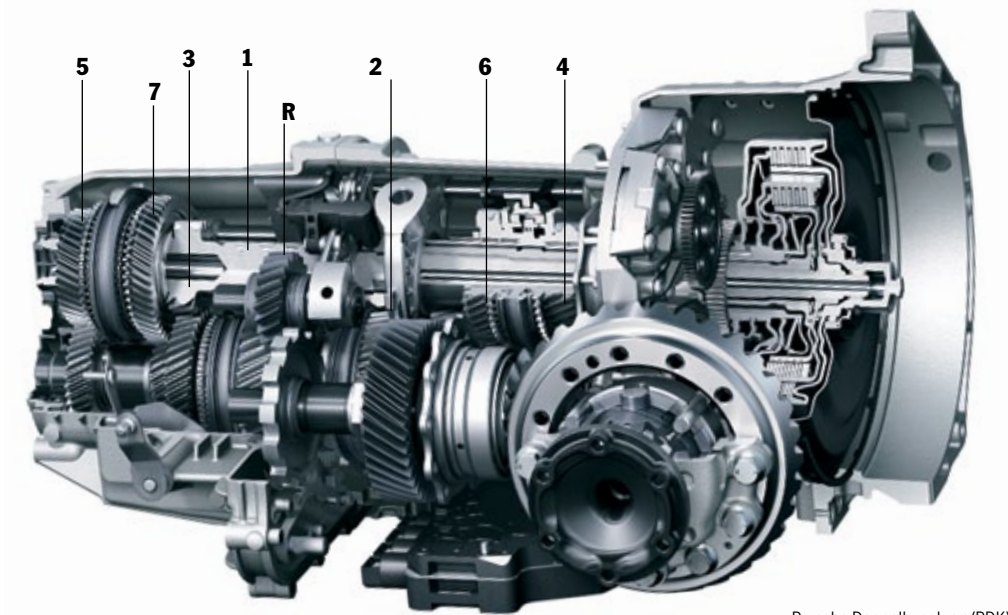

Porsche Doppelkupplung (PDK)

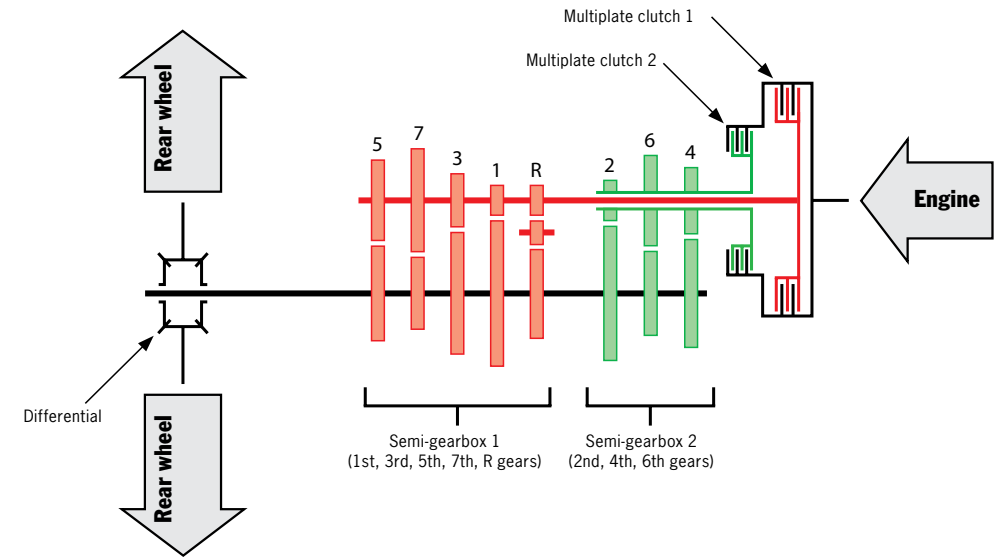

PDK function diagram

### Porsche Doppelkupplung (PDK) in detail.

The crankshaft transmits engine torque to the dual-mass flywheel which is then channeled through the clutch housing and onto the multiplate clutches, or to be more precise, the outer disc carrier.

Under oil pressure, clutch 1 closes and forms a frictional connection with input shaft 1. The torque is now transmitted through the differential to the rear axle. At this stage, PDK has already preselected the next gear. Engine torque is already acting on the other outer disc carrier and, in response to a gear-change signal, the overlap shift is initiated, i.e., as clutch

1 opens, clutch 2 closes. The non-positive connection with input shaft 2 is established, and power is transmitted to the wheels. The gear that is engaged is displayed on the instrument cluster. Depending on the gearshift program, the gear change is optimized for comfort or for sporty handling, and takes place in a matter of milliseconds.

The advantages over a fully manual transmission are very rapid gearshifts with no interruption in the flow of power, which results in a considerably faster rate of acceleration with a slightly reduced rate of fuel consumption. The advantage over a fully automatic transmission is the perceptible increase in driving dynamics—with a similar level

of comfort, and a distinct reduction in fuel consumption.

The compact dimensions of the gearbox reduce rotational masses, which means that the engine response is more direct and the system is more lightweight.

This, along with the long-ratio 7th gear, helps to achieve reduced

fuel consumption and emissions figures comparable with those of a manual gearbox. With the optional Sport Chrono Package, PDK is enhanced by the “Launch Control” and motorsport-derived gearshift strategy functions.

In essence, PDK combines sportiness with efficiency and comfort. What does all this mean for you? Exactly what you would expect: uninterrupted driving pleasure.



Sport steering wheel with gearshift switches



SportDesign steering wheel with gearshift paddles



Gear selector for PDK



Gear lever in Carbon Fiber

### Sport steering wheel

In conjunction with the optional Porsche Doppelkupplung (PDK), the standard sport steering wheel has two ergonomic switches.

One press with the thumb and PDK shifts up. One pull with the index finger and PDK shifts down. When combined with one of the optional Sport Chrono Packages, there is an additional display above the airbag module. It tells you whether the “Sport,” “Sport Plus,” and Launch Control functions are activated.

### SportDesign steering wheel.

Visually, this steering wheel is distinguished by its high-quality twin-spoke design and silver-colored galvanized spoke cover. The airbag module is finished in the same color as the steering-wheel rim.

This optional steering wheel allows you to make motorsport-style gear changes. In conjunction with the optional PDK, the SportDesign steering wheel features two alloy shift paddles ergonomically located behind the steering-wheel spokes. Pull the right-hand paddle and the

PDK shifts up. Pull the left-hand paddle and the PDK shifts down. A display on the left and right steering-wheel spokes tells you whether the Sport, Sport Plus, and Launch Control functions of the optional Sport Chrono Package are activated. Another feature reminiscent of the world of motorsport is the top center marking on the steering-wheel rim.

### Gear selector for Porsche Doppelkupplung (PDK).

The gear selector for PDK impresses not only with its unique design, but above all

with its superior functionality, enabling you to change gear manually: Press forward to shift up; pull backward to shift down.

Even if the gear selector is set to automatic mode, you can still change gear manually using the switches or gearshift paddles on the steering wheel.

### Six-speed manual gearbox.

Fitted as standard in each of the Cayman models is a six-speed manual gearbox. The shift throw is short and precise;

the tuning is sporty—as befits the character of the Cayman models. The dual-mass flywheel minimizes engine noise and the control cable mechanism prevents vibrations from being transmitted to the gear lever.

### Hill Start Assist.

Hill Start Assist comes as standard for manual and Porsche Doppelkupplung (PDK) transmissions. It assists the driver in making a comfortable, smooth, and roll-free start on a hill.

The system automatically detects that the vehicle has been braked to a halt on an incline. Provided a gear is engaged, the brake pressure is maintained at all four wheels for approximately two seconds once the footbrake is released. The vehicle is therefore temporarily prevented from rolling backward. Brake pressure is reduced if, within two seconds, sufficient revs have been generated by the driver depressing the accelerator pedal (or, in the case of manual transmission, the accelerator pedal is depressed and the clutch is engaged).





## Chassis

Take the long way home.

If you have a spirited nature like the Cayman models, you will need a chassis that can cope with the challenges of the road ahead—and master them with precision. How is this achieved?

All components must be the perfect match. There's only one goal: to be able to fully express one's desire for performance.

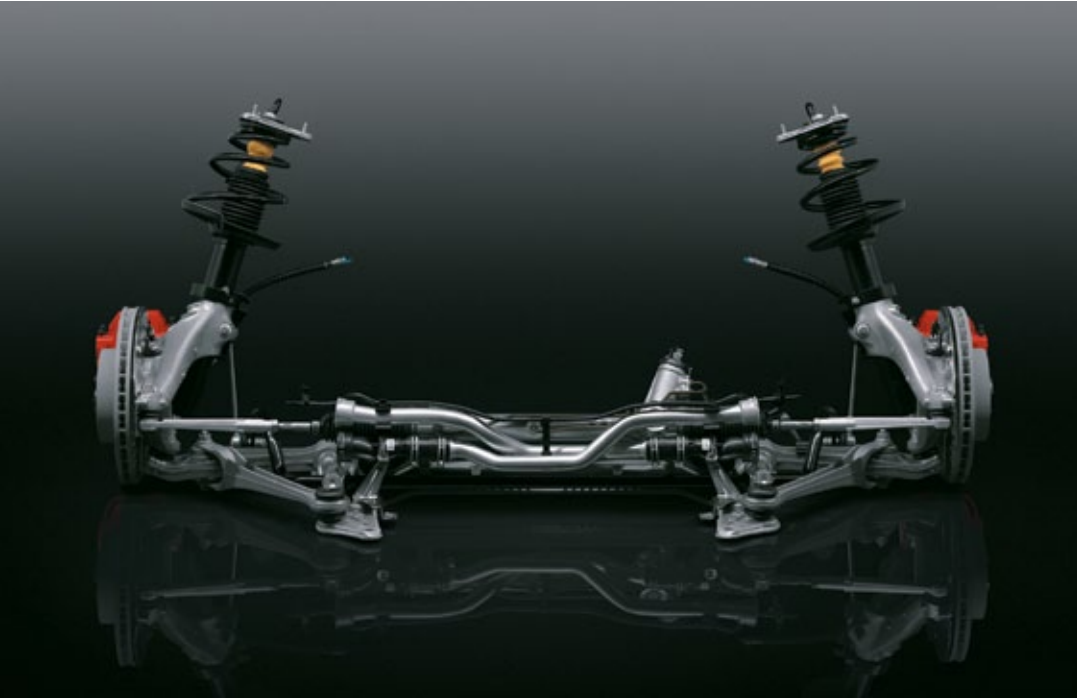

Lightweight spring-strut front axle on the Cayman S

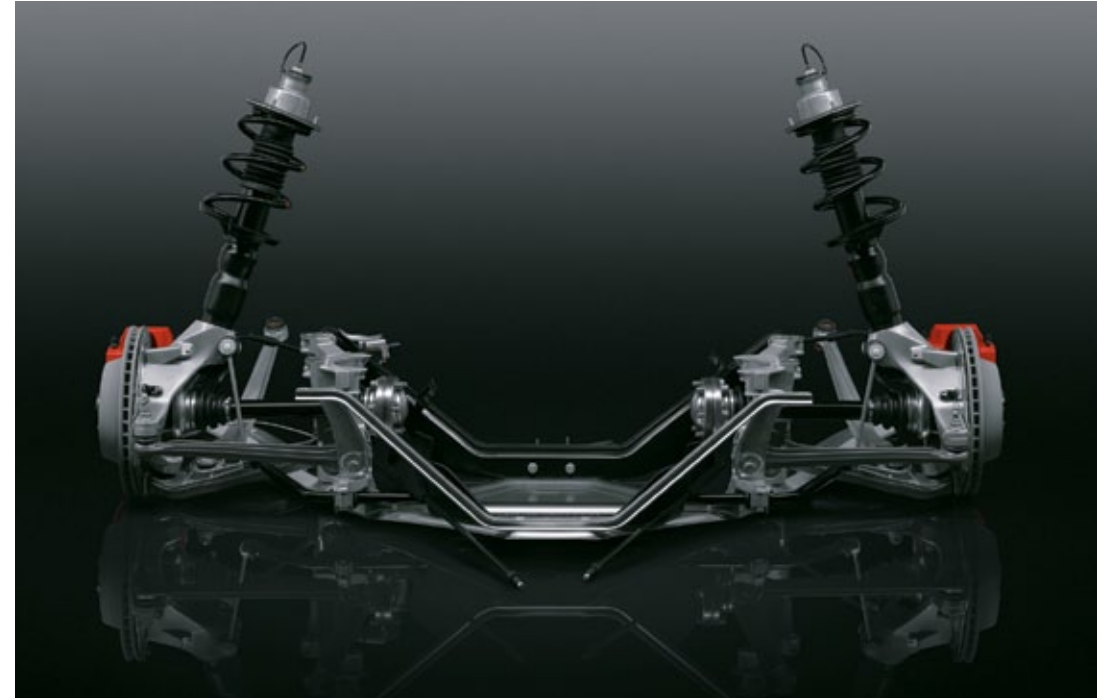

Lightweight spring-strut rear axle on the Cayman S

**Engineered to devour every corner.  
And consume every wrinkle in the road.**

**Chassis.**

The Cayman models follow a clear line. Their own. Even when it comes to the chassis. The driver's connection to the road is an essential priority

at all times, along with the delivery of the engine's power.

For this reason, the Cayman models are equipped with a lightweight suspension with transverse links and spring

struts, front and rear. The spring and damper unit and the anti-roll bar unit have been tuned for exceptional driving dynamics combined with a high level of driving comfort. For Porsche, that is not a contradiction.

During fast lane changes and through tight corners, this chassis is in its element. Thanks to the mid-engine layout and the construction of the bodyshell, roll and pitch are practically eliminated. The chassis responds

with precision to acceleration and braking. The lightweight construction keeps the vehicle gross weight and the weight of the unsprung masses low. Virtually all moving axle parts are made of aluminum.

Driving stability is excellent, even in the event of considerable load changes—thanks not least to the vehicle's generous track width. High levels of safety and a consistently dynamic driving experience are the result.

## Steering.

What use is a perfect suspension setup without perfectly tuned steering? For Porsche, this would be inconceivable. The solution is a steering system that works with as much precision and immediacy as the chassis itself and, thanks to the power

assistance, steering effort is reduced to a comfortable level. Around the straight-ahead position, such as during highway driving, the ratio is less direct with no loss of agility or feedback. The greater the steering angle, the more direct the steering ratio. This is particularly noticeable through

tight curves and when parking, and provides a high level of active safety and a more immediate driving response. The car has a turning circle of just 36.4 feet (11.1 m). The steering wheel also adjusts for height and reach.



Cayman S



Cayman S



17-inch Cayman II wheel



18-inch Cayman S II wheel

## Wheels.

The Cayman is fitted with 17-inch wheels as standard. The star-shaped design expresses sheer sportiness and allows an eye-catching view of the brake calipers. The Cayman S is fitted with large 18-inch wheels as standard, and the turbine-like arrangement of the spokes gives the car an extremely powerful look. 19-inch wheels are available for both models on request. All available wheels are equipped with anti-theft protection.

## Tire Pressure Monitoring System (TPMS).

The standard Tire Pressure Monitoring System (TPMS) sends warnings to the onboard computer's display screen in the event of low tire pressure. The driver can check the pressure in all four tires from the instrument cluster. The system updates quickly and accurately after an engine start, tire pressure correction, or wheel change—for increased comfort and safety.

### Porsche Active Suspension Management (PASM).

The optional PASM is an electronic damping-control system. PASM actively and continuously regulates the damping force for each wheel according to the road conditions and driving style. In addition, the suspension is lowered by 0.39 of an inch (10 mm).

The driver can select between two different modes: “Normal,” which is a blend of performance and comfort, and “Sport,” where the setup is much firmer. Depending on the mode selected, therefore, PASM is sportier or more comfortable than with the standard chassis. The PASM control unit evaluates the driving conditions and modifies the damping force on each of the wheels in accordance with the selected mode.

Sensors monitor the movement of the vehicle body, for example, under heavy acceleration and braking or on uneven roads. The control unit tunes the dampers to the optimal hardness for the selected mode to reduce roll and pitch still further, and to increase contact between each individual wheel and the road.

In Sport mode, the suspension is set to a harder damper rating. On uneven roads, PASM immediately switches to a softer rating within the Sport setup range, thereby improving contact between the wheels and the road. When the road surface improves, PASM automatically reverts to the original, harder rating.

If Normal mode is selected and the driver’s style becomes more assertive, PASM automatically switches to a harder rating within the Normal setup range. Damping becomes harder, and driving stability and road safety are increased.

### Mechanically locking rear differential.

Are you a fan of sporty driving? Then you shouldn’t do without the optional mechanically locking rear differential available in conjunction with 18-inch or 19-inch wheels. It further enhances the traction of the driven rear wheels on uneven roads and when accelerating out of tight curves, and the damping of load-change reactions during fast cornering is reduced. Roadholding at the limits of performance is even more impressive. The car holds its course better and so PSM intervenes less often.

In other words, sheer driving pleasure and faster lap times.



Rebound in Normal mode—working piston and bypass, sporty-comfortable tuning



Rebound in Sport mode—working piston only, sporty-hard tuning



Compression in Normal mode—working piston and bypass, sporty-comfortable tuning



Compression in Sport mode—working piston only, sporty-hard tuning



Sport Chrono stopwatch

### Sport Chrono Package.

Do you think driving a Porsche should be an even more involving experience than it is already? Your wish is our command. On request, we can equip your vehicle with the Sport Chrono Package, which is available for both of the Cayman models. Its functions enable even sportier tuning of the engine and chassis, and guarantee even more driving pleasure.

Selecting the Sport button on the center console activates

Sport mode, which makes throttle response significantly more immediate, adjusts the rev limiter to a harder setting, and tunes the engine dynamics for performance driving.

The optional Porsche Active Suspension Management (PASM) also switches to Sport mode, which offers harder damping and more direct steering and, therefore, better roadholding.

With the optional PDK in automatic mode, gearshift points are delayed until the

upper rev range. The shift times are shorter, the gear changes sportier. At low rates of deceleration, the system initiates a swifter, brake-induced downshift. In manual mode, gear changes are faster and more dynamic. In Sport mode, the PSM system intervenes later for increased longitudinal and lateral dynamics. PSM now affords greater maneuverability under braking and exit acceleration, especially at low speeds.

For maximum dexterity, PSM can be set to standby while the

car is still in Sport mode. For safety, it is set to intervene automatically only when ABS assistance is required on both front wheels.

A key component of the Sport Chrono Package is the swivel-mounted stopwatch in the center of the dashboard, with analog and digital display.

In combination with Porsche Doppelkupplung (PDK), the Sport Chrono Package offers two additional functions that are activated by the Sport Plus button.

First, Launch Control, which ensures you achieve the fastest possible rate of acceleration from a standing start—on the racetrack, for example. Launch Control is operated via the Sport Plus button with the “D” or “M” drive position selected. While the driver depresses the brake pedal with the left foot, the right foot depresses the accelerator pedal to the floor. With the accelerator in the kickdown position, the system detects the driver’s

request for Launch mode and revs the engine to an optimal speed of approximately 6500 rpm. Engine torque increases and the clutch closes slightly. The message “Launch Control” appears on the display on the steering wheel for PDK. The driver now quickly releases the brake—and prepares for maximum acceleration.

Second, the motorsport-derived gearshift strategy. Using this, PDK is geared up for maximum shift speed, the shortest possible shift times, and optimal shift points for maximum acceleration—for uncompromising performance.

### Sport Chrono Package Plus.

On request, the optional Porsche Communication Management (PCM) can be combined with the Sport Chrono Package Plus. In addition to the functions of the Sport Chrono Package, it includes a personal memory function, which can be controlled using PCM, and a performance display for evaluating lap times.



Sport and Sport Plus buttons on the center console



Three-spoke sport steering wheel with gearshift switches

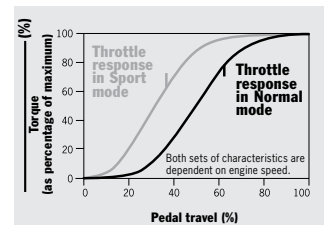

Comparison of the ETC characteristic curve in Normal and Sport modes



# safety

**A controlled offensive.  
Even on the defensive.**

The Cayman models are uncompromising sports cars. In every respect. The same applies to safety. Active as well as passive. Trust alone is not

enough. You have to be confident about your vehicle. So we've taken care of it. Anything else just wouldn't be Porsche.

**There can be no driving pleasure without peace of mind. Introducing the safety features of the Cayman models.**

**Active safety.**

Active safety is a topic that Porsche actively supports. With generous safety margins, even the suspension tuning makes a decisive contribution. Optimal acceleration enables rapid overtaking, and optimal braking minimizes stopping distances. Safe contact with the road is provided not only by the wheel/tire combination, but also by

the auto-deploying biplane rear spoiler and aerodynamic front end. Another important standard safety feature is Porsche Stability Management (PSM).

See and be seen. This is a slogan that typifies the headlights concept. The design is unmistakable, the brightness unmissable. The halogen headlights with LED position lights in the front light unit help

to ensure clear visibility at all times. The low front fog lights offer outstanding illumination, and a high-level third brake light is neatly integrated into the rear window. LED technology is used in the taillights, brake lights, and rear fog light to provide better illumination and respond more quickly to driver input.

**Bi-Xenon™ headlights with dynamic cornering lights and LED daytime running lights.**

Available as an option for the Cayman models are Bi-Xenon™ headlights including dynamic cornering lights and LED daytime running lights. Bi-Xenon™ headlights are about twice as powerful as halogen headlights, so they offer improved visibility and illuminate the road more evenly. In fact, they are so effective that fog lights are no longer necessary. A headlight-cleaning system is built in.

Dynamic cornering lights offer particularly effective illumination of the road ahead, particularly through curves. Sensors continuously monitor the speed, lateral acceleration, and steering lock and, from these variables, calculate the course of the curve. This determines the angle of the dynamic cornering lights, with the lights able to swivel toward the inside of the bend up to a limit of 15 degrees, even with the high beam switched on.



Night design, front



Night design, rear



Bi-Xenon™ headlights with dynamic cornering lights and LED daytime running lights



Cayman S



### Braking system.

The acceleration of the Cayman models is impressive. Even more impressive, perhaps, is the vehicle's maximum braking power, which comfortably tames the power of the engine.

Four-piston, aluminum monobloc brake calipers are fitted front and rear. Offering excellent rigidity, they are compact and save on weight. Their superior responsiveness, for fast and sensitive braking, sets them apart. A brake booster provides assistance, reducing pedal effort while maintaining a powerful braking effect.

A special ventilation system, whereby the entire wheel brake is supplied with cooling air by openings in the front end and special channeling systems, increases the stability of the brakes during heavy use.

The front axle of the Cayman and Cayman S features internally vented brake discs with a diameter of 12.5 inches (318 mm). 11.8-inch (299mm) brake discs are fitted to the rear axle. The result is outstanding braking performance. The rear brake discs of the Cayman S are 0.16 of an inch (4 mm) thicker than those of the Cayman, which increases stability under load even further. To distinguish them visually, the brake calipers on the Cayman have a black anodized finish, while those on the Cayman S are painted red.

For reduced weight, optimal braking in wet conditions, and improved cooling, the brake discs on both models are cross-drilled.

For the Cayman S, the Porsche Ceramic Composite Brakes (PCCB) are available as an option.



Standard brake unit (Cayman)



Standard brake unit (Cayman S)



Porsche Ceramic Composite Brakes (PCCB)





Cayman S with PCCB

### **Porsche Ceramic Composite Brakes (PCCB).**

On request, we can equip your Cayman S with a brake system that has already had to cope with the harshest requirements of motorsport: the Porsche Ceramic Composite Brakes (PCCB). The ceramic brake discs have a diameter of 13.78 inches (350 mm) front and rear—for

extremely powerful braking. The brake discs are formed from a specially treated carbon-fiber compound that is silicated in a high-vacuum process at approximately 3,100°F (1,700°C). Not only are the resulting discs much harder than standard discs, but they are more resistant to heat. The low thermal expansion of the brake discs prevents deformation under

heavy braking. Furthermore, the ceramic brake discs are totally resistant to corrosion and offer more favorable noise-damping properties.

Six-piston, aluminum monobloc fixed calipers on the front axle and four-piston units at the rear provide a high and constant brake pressure. The pedal

response is fast and precise with only moderate input required. All the necessary ingredients are there for a short braking distance. Moreover, safety under braking at high speeds is increased, thanks to the excellent fade resistance of PCCB.

The key advantage of PCCB is that the brake discs are approximately 50-percent lighter

than standard discs of similar design and size. A factor that helps to reduce unsprung and rotating masses on the vehicle. The consequences of this are better roadholding and increased comfort, particularly on uneven roads, as well as greater agility and improved handling.

Please note that circuit racing, track-day use, and other forms

of performance driving can significantly reduce the service life of even the most durable brake pads and discs. We recommend that all brake components be professionally inspected and replaced where necessary after every track event.



Cayman

### Porsche Stability Management (PSM).

PSM, which comes as standard, is an automatic control system that stabilizes the vehicle at the limits of dynamic driving performance. Sensors continuously monitor driving direction, speed, yaw velocity, and lateral acceleration. Using this information, PSM computes the actual direction of motion. If this direction deviates from the desired course, PSM initiates braking interventions targeted at individual wheels in order to help stabilize the vehicle.

Under acceleration on wet or low-grip road surfaces, PSM improves traction using the ABD (Automatic Brake Differential) and ASR (Anti-Slip Regulation) functions, giving an agile response. When Sport mode is selected on the optional Sport Chrono Packages, the PSM intervention threshold is raised to enable greater driver involvement—particularly at speeds of up to approximately 45 mph. The integrated ABS (Anti-lock Brake System) can further reduce the braking distance. For an even sportier

drive, PSM can be deactivated. However, it is automatically reactivated for your safety if either of the front wheels (in Sport mode, both of the front wheels) requires ABS assistance. ABD remains permanently active. Two additional functions of PSM increase safety even further: precharging of the brake system, and Brake Assist. If you suddenly release the accelerator pedal, PSM automatically readies the braking system. With the braking system having been precharged, the brake pads are already in light contact with the brake

discs. Maximum braking power is therefore achieved much sooner. When sudden braking is detected, the Brake Assist function applies maximum brake pressure to all four wheels.

### Passive safety: engineered design.

The system of longitudinal and transverse members at the front of the vehicle (1) distributes the forces exerted onto the bodyshell in the event of an impact and minimizes deformation of the passenger cell. Our patented bodywork structure with a rigid bulkhead crossmember (2) made of ultra high-strength steel

absorbs the forces introduced into the system of longitudinal members, which prevents deformation of the footwell. The reinforced doors (3) contribute to the overall rigidity of the car. The forces exerted in a frontal collision are transmitted into the side structure along a higher load path (4), which improves the deformation characteristics of the passenger cell even further.

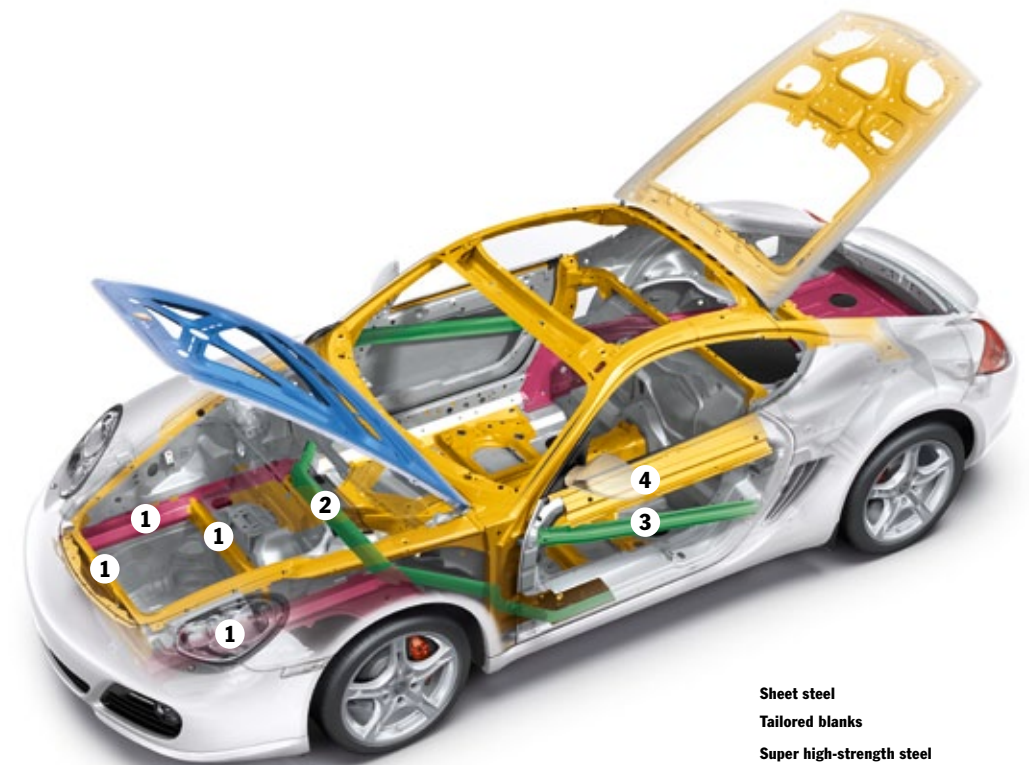

Sheet steel  
Tailored blanks  
Super high-strength steel  
Ultra high-strength steel  
Aluminum

**Passive safety: airbags.**

Each of the full-size airbags is inflated in two stages, depending on the severity of an accident. In less serious accidents, the airbags are only partially inflated, thereby minimizing discomfort for the occupants. Also fitted as standard is Porsche Side Impact Protection (POSIP). It comprises

side impact protection elements in the doors and two airbags on each side. An integral thorax airbag is located in the seat backrests, while each door panel contains a head airbag. With each having a volume of approximately 0.28 cubic feet (8 liters), these airbags offer excellent protection in the event of a side impact.

Other passive safety features include headrests integrated into the seat backrests, an energy-absorbing steering column, three-point seat belts, seat-belt pretensioners and force limiters, energy-absorbing elements in the dashboard, and flame-resistant materials throughout the interior.



Cayman



Porsche Side Impact Protection (POSIP)

**Anti-theft protection.**

Both models are equipped with an immobilizer with in-key transponder. In addition, the Cayman S has an alarm system with contact-sensitive exterior protection as standard (optional for the Cayman). It is activated and deactivated by the remote control integrated in the ignition key, which is also used to lock and unlock the doors. Radar-based interior surveillance is available as an option for both models.

**Child seats.<sup>1</sup>**

A full range of child seats with LATCH mountings and a deactivation function for the passenger airbag are available from Porsche Tequipment.

<sup>1</sup>Child seats must not be used with sport bucket seats.



## Comfort

**This is not an ordinary sports car.  
But this doesn't mean it cannot be put to ordinary use.**

Just how much comfort can you expect from an uncompromising sports car? A great deal. After all, if you want to express your

personal freedom, you should never have to feel constrained. It's a Porsche philosophy.

**From a weekend drive to the daily commute.  
Everyday practicality.**

### Comfort in the Cayman models.

Not for Sunday drivers, yet built to be driven 365 days a year. It's a Porsche principle to which even the Cayman models have had to adhere. No wonder they

are regarded as an everyday sports car. The low seat position, the dome-shaped roof, and the large windows create an airy feeling of space. Seating comfort

is exemplary. The ergonomics are typically Porsche. Every control is within easy reach.

The CDR-30 audio system is just one of the many standard features you will find on the center console. The luggage concept is also the result of the

ingenuity of our designers, with a luggage compartment at the front and a spacious rear trunk.

In short, your Cayman has been designed with everyday enjoyment in mind. Ordinary enjoyment, however, would not be Porsche.



Cayman S interior with optional equipment, including sport bucket seats and personalized accessories from the Porsche Exclusive range



Cayman S dashboard with optional equipment, including PCM, Tire Pressure Monitoring System (TPMS), Sport Chrono Package Plus, and PDK

### Instruments.

Each black circular dial in the instrument cluster—aluminum-colored in the Cayman S model—provides important information at a glance. In the center is the analog rev counter with digital speedometer and a customizable display of key data from the standard onboard computer. Additional data, such

as average fuel consumption, fuel range, or the data of the TPMS, can be shown as desired.

The right-hand dial displays a range of information, including the outside temperature and shift pattern of the optional Porsche Doppelkupplung (PDK), as well as the selected gear. The dial on the left contains the analog speedometer with digital trip

meter and total distance display. The design and legibility of the dials are also enhanced by the white backlit illumination.

### Steering wheels.

The Cayman models feature as standard a three-spoke sport steering wheel with full-size airbag. The steering wheel is adjustable for height and reach, and the rim is in Smooth-Finish Leather. As an option, you can specify a three-spoke multifunction steering wheel in leather with integrated buttons

for the most essential audio and, where applicable, navigation and telephone functions. Alternatively, the multifunction steering wheel is available in Smooth-Finish Leather, Aluminum-Look, Carbon Fiber, or Makassar wood.

Fitted as standard in conjunction with Porsche Doppelkupplung (PDK) is the three-spoke sport steering wheel with gearshift

switches. A multifunction version of this steering wheel is offered as an option. Also available as an option is the three-spoke sport steering wheel with gearshift paddles. For extra comfort on those cold days, steering-wheel heating is available on request for all steering wheels (steering-wheel heating available only in conjunction with heated seats).



Power seat with driver memory



Adaptive Sport Seat with driver memory



Sport bucket seat



Automatic climate control

### Standard seats.

The standard seats offer a high degree of comfort with good lateral support and optimized under-seat suspension. Through curves, your seat gives you a feeling of security without restriction. The seats are equipped as standard with manual height and fore/aft adjustment and an electric backrest adjustment, enabling virtually every driver to find the ideal seat position, regardless of physical build.

### Power seats with driver memory.

Power seats with electric fore/aft, height, backrest, and lumbar support adjustment are available as an option. The tilt angle of the

seat cushion is also electrically adjustable. The memory function supports the exterior mirrors and all seat positions on the driver side. Using the control switches in the door panel, it is possible to restore one of two personalized settings. Additionally, you can store a further seat position in each of the ignition keys. As soon as you unlock the door using the key remote, the driver seat and exterior mirrors resume their stored positions.

### Sport seats.

The optional sport seats have firmer leather upholstery than that of the standard design. Higher side bolsters on the seat cushion and backrest provide additional lateral support. The

seat height and fore/aft position are adjusted manually, the backrest electrically.

### Adaptive Sport Seats with driver memory.

The optional Adaptive Sport Seats in leather upholstery combine excellent comfort with first-rate track performance. Along with all the adjustment features of the power seats, the side bolsters on the seat surface and backrest are individually electrically adjustable, for increased comfort on long journeys and tailor-made lateral support through curves or on the racetrack. The memory function supports the exterior mirrors and all driver seat positions, apart from the side bolsters.

### Sport bucket seats.<sup>1</sup>

For the ultimate sports experience, you could opt for sport bucket seats with a folding backrest, integral thorax airbag, and manual fore/aft adjustment. The backrest shell is made from glass/Carbon Fiber-reinforced plastic and has a stylish Carbon Fiber-weave finish. The backrest pivots are positioned high in the side bolsters to provide lateral support to the pelvic region, characteristic of a race seat. The seat upholstery is offered in all available leather types and colors.

### Seat heating and ventilation.

As an option, all compatible seats—apart from sport bucket seats—can be equipped with two-level seat heating. Seat ventilation for the standard seats and power seats is also available as an option (only in conjunction with heated seats and automatic climate control). A slipstream effect evaporates perspiration moisture—for a comfortable seating environment. Ventilation intensity can be set to any of three levels.

### Air conditioning.

Both Cayman models come with a powerful and quiet air-conditioning system as standard. The optional climate control system offers even more uniform and comfortable ventilation.

<sup>1</sup>Child seats must not be used with sport bucket seats.



Rear window

### “Welcome Home” lighting.

When the vehicle is opened or closed using the key remote, the standard automatic locator lighting automatically switches on the fog lights and LED daytime running lights. This is particularly convenient at night. In conjunction with the optional PCM and Sport Chrono Package Plus, the delayed lighting switch-off period can be adjusted as desired.

### HomeLink® (programmable garage door opener).

The optional programmable garage door opener is integrated into the overhead console and remotely controls up to three different garage doors, gates, home lighting, and/or alarm systems.

### Water-repellent side windows.

The surfaces of the side windows are treated with a water-repellent coating so that not only water but dirt also runs away more easily, thereby providing optimal visibility even in poor weather.

### Windshield wipers.

The windshield wipers with an adjustable intermittent wipe speed are aerodynamic and inconspicuous. The windshield



Cayman with ParkAssist

washer system has two heated and filtered nozzles. An integrated rain sensor is available as an option (in conjunction with auto-dimming mirrors).

### Rear window.

The rear window is tinted and has heating functionality. Its generous size affords excellent rearward visibility. A detachable fabric screen on the inside of the rear lid provides additional privacy for the main luggage area.

### Rear wiper.

The Cayman models can be equipped with an effective and streamlined rear wiper on request. It is styled to blend seamlessly into the overall design of the vehicle.

### ParkAssist.

As soon as Reverse gear is engaged, the optional ParkAssist is activated automatically. If the vehicle moves too close to an obstacle, a warning signal begins to sound, becoming faster until the car stops. The sensors of the optional ParkAssist are neatly concealed in the rear bumper.





Cayman with matching luggage set from the Porsche Design Driver's Selection

### Storage.

The Cayman models satisfy your need for independence, whatever your destination or purpose. After all, there are occasions when you don't get into your car merely for the sake of it. Sometimes you simply need to get from "A to B." Such as a trip to the shops, or to pursue your favorite leisure activities. With their generous transport concept,

which includes two luggage compartments, a wide range of storage spaces, and the optional Roof Transport System, the Cayman models are extremely practical. And, of course, they still offer an abundance of driving pleasure, whatever the reason for your journey.

### Front luggage compartment.

The front luggage compartment is lined with black carpet and offers 5.3 cubic feet (150 liters) of loadspace.

### Rear luggage space.

The luggage space located beneath the upholstered rear lid is lined with carpet in the interior color and consists of both a

storage surface above the engine cover and the luggage compartment behind it. This design enables the convenient loading of longer items of luggage. It has a capacity of 9.2 cubic feet (260 liters) and a high-quality finish. On request, you can have the panels surrounding the engine cover and the integral strut tower moldings finished in the vehicle's exterior color.

A retaining rail at the front of the engine cover helps to secure any luggage under braking. A luggage stop behind the seats is also available as an option. Smaller items can be secured on top of the engine cover using a luggage net with four lashing eyelets. A Stainless Steel partition provides an elegant transition to the lower rear luggage area. This is the ideal space for larger items and also has four lashing eyelets for attaching a luggage net.

Another useful feature is the covered service opening, which conceals the conveniently located coolant and engine oil-filler tubes.



Front luggage compartment



Rear luggage space



Luggage stop



Rear luggage space

### Storage compartments.

The interior of the Cayman models is packed with a wide range of ingenious and ergonomically positioned storage spaces. On the passenger side there is a large, lockable glove compartment, which will contain integral CD storage, if you have selected an optional sound system. Other storage compartments can be found beneath the radio or PCM, in the rear center console, and in the door armrests. In the Cayman S, the lids of these compartments are trimmed in leather. Between the two seats, on the engine bulkhead, is another compartment offering 275 cubic inches (4.5 liters) of storage space. The dashboard trim strip neatly conceals two separate cupholders.



Door compartment



Lockable glove compartment



Cupholder

### Roof Transport System.

The optional Roof Transport System is aerodynamically efficient and made of aluminum. Its low weight and uncomplicated mechanism make it easy to fit. A

range of attachments is available for the Roof Transport System, such as a roof box and carriers for bikes and skis/snowboards—for sporty activities 365 days a year. The maximum permissible roof load is 132 pounds (60 kg).

The preparation for mounting the Roof Transport System is fitted as standard, while attachments are available from Porsche Tequipment through your authorized Porsche dealer.



Cayman Roof Transport System

## Technology that speaks your language. In music.

### Porsche audio and communication systems.

Admittedly, to outperform the distinctively powerful Porsche sound is a real challenge. Nevertheless, we've tried and have developed audio systems that offer a genuine alternative.

#### CDR-30 audio system.

Both Cayman models are equipped as standard with the CDR-30 audio system with a five-inch display (monochrome) and an MP3-compatible CD drive. An

integrated six-disc CD/DVD changer is available as an option.

The FM dual tuner with RDS diversity, a total of 30 memory presets, Dynamic Autostore, and speed-sensitive volume control are, as usual, all part of the standard package. Just like the high-quality sound, which is delivered by two high-range speakers in the dashboard, two low-/mid-range speakers in the door panels, and two 25-watt amplifiers. For an even more

impressive sound experience, you could opt for the Sound Package Plus or Bose® Surround Sound system.

Controlling the CDR-30 could not be simpler: The function keys ensure that all the main functions are directly at your fingertips, and it is possible to conveniently control all of the most important functions using the buttons on any of the optional multifunction steering wheels.



CDR-30 audio system

## No time for instruction manuals? We thought as much.

### Porsche Communication Management (PCM) including navigation module.

As the central control unit for audio, navigation, and communications, the optional PCM is multifunctional and ergonomic to operate.

The main feature is the 6.5-inch color touchscreen with a durable, easy-to-clean coating. Functional, innovative, and easy to use, you will find the display very clearly presented, and a maximum of five list entries per page enables you to operate the unit quickly and safely. Alternatively, you can choose to operate the PCM using the rotary pushbutton on the right.

Radio functions include up to 48 memory presets and an FM dual-tuner frequency diversity with RDS, which continuously scans in the background for the best signal. The integrated single CD/DVD drive supports the MP3 format and—in combination with the optional Bose® Surround Sound system—is able to play back music from audio and video DVDs in 5.1 digital format. An integrated

six-disc CD/DVD changer with MP3 playback is also available as an option for PCM.

#### Navigation module for PCM.

The GPS navigation system included with the optional PCM has an internal hard drive containing maps for most areas. A touchscreen enables rapid destination input and instant viewing of traffic information and points of interest (POIs) by simply allowing you to touch the symbols on the map. Route diversions, e.g., the nearest service stations, can therefore be incorporated quickly and easily into the current route guidance. When viewing a map, it is possible to select between a 3-D perspective and the 2-D display. At highway exits, graphical turn indications are displayed for better orientation. In split-screen mode, you can choose to display not only the current map overview, but also a list of icons that represent dynamic route guidance.

#### Electronic logbook for PCM.

The optional electronic logbook enables automatic recording of relevant driving data. Once you have downloaded the logbooks via Bluetooth® or the optional USB interface, you can evaluate them on your home PC using the software supplied.



3-D map view with turn notification



2-D map view



Porsche Communication Management (PCM)

### Voice-control system for PCM.

Almost all of the functions of the PCM can be controlled using the latest optional voice-control system with word-by-word input. The menu item is read aloud exactly as it is displayed on the screen and the voice-control system recognizes commands or sequences of numbers, no matter the speaker. It then gives an audible acknowledgment and carries out the functions you request. There is no need to “train” the system.

### Bluetooth® hands-free phone profile.

To enable Bluetooth® connection for those mobile phones that only support the Hands-Free Profile (HFP), standard mobile phone preparation is included. With HFP, PCM acts merely as a hands-free system. Here, too, the mobile phone can remain tucked away. PCM can be used to control only the basic functions of the phone.

### Universal audio interface for PCM and CDR-30.

With this standard feature, the storage compartment in the center console will, in conjunction with the optional PCM, contain up to three connections: one for your iPod®, one for a USB stick/MP3 player, and one as an AUX interface for any compatible audio source of your choice. The iPod® or USB stick can be controlled conveniently and safely using PCM. Through the USB socket, it is also possible to download data from the performance display of the Sport Chrono Package Plus, as well as data from the electronic logbook.

In conjunction with the CDR-30 audio system that comes as standard, the standard universal audio interface features an AUX socket for connecting any other type of audio source.

### Sound Package Plus for PCM and CDR-30.

With this standard feature, the storage compartment in the center console in combination with the optional PCM will contain up to three connections: one for your iPod®, one for a USB stick/MP3 player, and one as an AUX interface for any compatible audio source of your choice. The iPod® or USB stick can be controlled conveniently and safely using the PCM. Through the USB socket, it is also possible to download data from the performance display of the Sport Chrono Package, as well as data from the electronic logbook. In conjunction with the CDR-30 audio system that comes as standard, there is an AUX socket for connecting any other type of audio source.

### CD or CD/DVD changer.

As an option, the CDR-30 audio system can be fitted with an integral six-disc changer, or for the optional PCM, an integral six-disc changer (DVD/audio output only in conjunction with PCM). Both are MP3-compatible, and hold up to six CDs or DVDs. They are easy to load via the input slot on the CDR-30 or PCM.

### XM® NavTraffic®.

XM® NavTraffic® works with your vehicle’s navigation system to display continuously updated traffic information. Pinpoint traffic incidents, accidents, and road closings. You can even determine average traffic speed and estimate travel time along your route. XM® NavTraffic® is available in over 100 markets and uses the best traffic information from the best sources. It will transform your navigation system from a device you use on occasion to something you’ll rely on every time you get behind the wheel. Don’t drive through traffic—drive around it with XM® NavTraffic®.

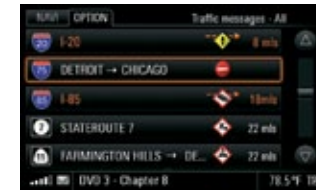

XM® NavTraffic®

### XM® Satellite Radio.

Everything worth listening to is on XM®. Get over 170 channels, including commercial-free music plus the best sports, news, talk, and entertainment. Get it all with coast-to-coast coverage, 24/7. Listen to every MLB® and NHL® game, NBA® coverage, the PGA TOUR® Network, and complete coverage of the American Le Mans Series® races; exclusive entertainment and talk including Oprah Radio®, *The Foxxhole* produced by Jamie Foxx, *Rosie Radio* with Rosie O’Donnell, Opie & Anthony, and Bob Edwards; plus comedy, kids’ programming, world-class news, and local traffic and weather.



XM® Satellite Radio

XM® NavTraffic® only available in select markets. XM® Satellite Radio and XM® NavTraffic® require subscriptions which automatically renew, and which are sold separately after trial period. Governed by XM Customer Agreement at [www.xmradio.com](http://www.xmradio.com). Fees and programming subject to change. Available only to those at least 18 years of age in the 48 contiguous USA and D.C. For more information, see [www.xmradio.com/navtraffic](http://www.xmradio.com/navtraffic). XM®, NavTraffic®, and all related marks and logos are trademarks of SIRIUS XM Radio Inc. and its subsidiaries. All other marks, channel names, and logos are the property of their respective owners. All rights reserved.

**Bose® Surround Sound system for PCM and CDR-30.**

The optional Bose® Surround Sound system is compatible with both the CDR-30 audio system, which comes as standard, and the optionally available PCM. Developed specifically for Porsche, it has been optimized for the Cayman models. A total of 10 loudspeakers—including an active subwoofer and central speaker, and a seven-channel digital amplifier with a total output of 385 watts—combine to produce a truly memorable sound experience.

During audio playback from audio or video DVDs (only in conjunction with the optional PCM), the system is able to make full use of the impressive sound spectrum of 5.1 digital recordings. With music in 5.1 digital format, the sound has already been recorded in a multichannel format and is faithfully reproduced exactly as the original.

Five dedicated audio channels (front left, front right, center, surround left, surround right) deliver a sound that is as authentic as it is natural. The digital 5.1 surround sound is balanced, lifelike, and crystal clear. It's a sound that's as true to a live performance or cinematic experience as you can get.

Of course, you can still play traditional music sources such as CDs (only format supported by CDR-30), either in stereo or in one of the surround modes generated by the patented Bose® Centerpoint® system. The algorithm of Centerpoint® 2 extracts an even more precise and realistic sound from the stereo signal.

The SurroundStage® signal processing circuitry developed by Bose® assigns each individual audio channel, whether sourced from a DVD or generated by Centerpoint®, to a selected combination of loudspeakers and is therefore able to deliver an optimally balanced surround-sound experience to both seat

positions. To complement these features, the Bose® Surround Sound system offers a comprehensive selection of equalizer presets for customized sound. The dynamic loudness function increases bass levels as you decrease the volume, thereby compensating for the decreasing sensitivity of the human ear at these frequencies. Moreover, the AudioPilot® Noise Compensation Technology uses a microphone to continuously measure the ambient noise inside the vehicle and adapts music playback automatically so that a consistent sound is maintained in all driving conditions.

The Bose® Surround Sound system. A genuine—perhaps the only—alternative to the characteristic engine sound.



2.5-inch (7.0cm) center speaker



Active subwoofer, 4-inch x 6-inch (10.2cm x 15.3cm) bass speaker in the passenger footwell



3-inch (8.0cm) neodymium mid-range speaker and 8-inch (20.0cm) Nd<sup>1</sup> bass speaker<sup>1</sup>

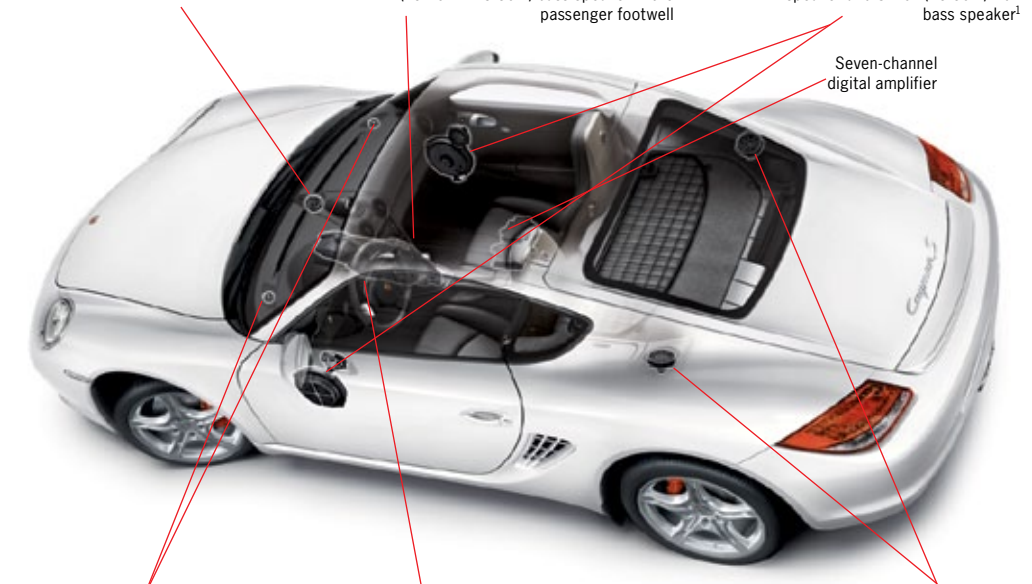

Seven-channel digital amplifier



1-inch (2.5cm) neodymium tweeter

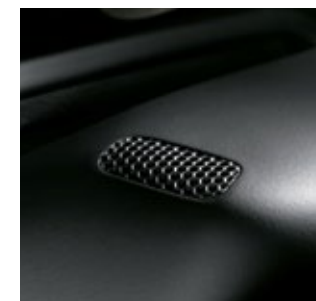

Microphone for AudioPilot® on the steering column



3-inch (8.0cm) neodymium mid-range speaker

<sup>1</sup>Neodymium subwoofer with Bose® patented technology for an extremely slim design and superior bass performance.



## Environment

**Challenge the laws of physics.  
While obeying the laws of nature.**

The Cayman models exude character. They are strong-willed, unyielding, but never disagreeable. It shows in their attitude, especially toward the environment. Resolute

compliance with environmental regulations is the law they follow. As do all Porsche models. Because efficiency, too, is a question of character.

## Top marks for cleanliness.

In an era of intensifying debate about global climate change and CO<sub>2</sub> emissions, every automotive manufacturer is asking itself what it has to offer in terms of environmental protection. Our answer has long been the same: maximum efficiency.

Over the last 15 years, Porsche has managed to reduce the fuel consumption of its vehicles by an average of 1.7 percent each year. Improvements in fuel economy also have a beneficial impact on CO<sub>2</sub> emissions. In relation to power output, Porsche is already among those manufacturers achieving the lowest CO<sub>2</sub> emissions. This has been achieved through Direct Fuel Injection (DFI), lightweight construction, optimal aerodynamics, and

low rolling resistance. This high level of environmental responsibility is clearly demonstrated by our approach to environmental management at the Porsche development center in Weissach. Here, all technological developments are carried out with environmental protection in mind. The goal? Pure performance—but not at the expense of the environment. A goal achieved by the Cayman models.

### Exhaust emissions control.

Both engines comply with stringent emissions standards, including LEV II in the USA. Vehicles manufactured by Porsche demonstrate that even high-performance sports

cars can achieve moderate emissions values in their respective category. In short, the Cayman is not only extremely sporty—it is also very clean.

This attribute is achieved by means of a two-stage cascade-type catalytic converter, which comprises two monolith substrates on each of the twin exhaust tracts. These specially coated substrates contain ultra-fine honeycomb channels in which pollutants are converted as exhaust gas passes through. The stereo Lambda circuitry controls and monitors each cylinder bank separately, while another Lambda Sensor® on each cylinder bank monitors pollutant conversion in the respective catalytic converter.







### **Fuel economy and recycling.**

At Porsche, a fundamental aspect of design is intelligent lightweight construction. For both economical and ecological reasons. This forms the basis for low fuel consumption values in conjunction with outstanding performance.

It is economical, thanks to the high proportion of aluminum cast alloys, plastics, and super-high-strength sheet steel used. This is substantially lighter and more stable than is conventional steel. In the Cayman models approximately 20 percent of the components is made from lightweight alloys. We use only innovative and environmentally friendly components, and each material is labeled to facilitate its separation for recycling. Recycled plastics are used where they meet exacting technical requirements. In all, the Cayman models are approximately 95-percent recyclable.

In addition, Porsche uses only environmentally friendly water-based paints. The Cayman is absolutely free of asbestos, CFCs, and components manufactured using CFCs. This is because, here at Porsche, environmental protection does not begin at the end of a vehicle's life. It starts at the planning and development stage.

### **Fuel.**

The Cayman models are already designed to operate on fuels with an ethanol content of up to 10 percent. Ethanol has a positive impact on the CO<sub>2</sub> balance since the plants cultivated for the production of this biofuel also absorb CO<sub>2</sub> from the atmosphere.

The active carbon filter and a special coating on the fuel tank reduce the amount of hydrocarbons released from the fuel system. All fuel lines are made of aluminum, while vapor-carrying lines are made from multilayered plastic.

### **Noise.**

The Cayman models comply with all applicable noise regulations without any form of engine encapsulation. To achieve this, noises are eliminated at source. Engine parts are stiff, moving parts are lightweight, and tolerances are kept to a minimum. Large-volume silencers and resonators in the air-intake system minimize noise further. For the entire service life of the vehicle.

### **Servicing.**

Long service intervals offer clear advantages. For you: lower costs and saved time. For the environment: the use of fewer consumables and replacement parts.



## Personalization

**We build the sports car.  
The rest is up to you.**

Admittedly, the Cayman models are already a declaration of individuality. But they're unable to express your individuality until you've given them your personal

touch. Using the wide range of available personalization options for inspiration, you can lend your Cayman model a very special kind of style: your own.



Cayman S with interior package in Stone Grey leather

**Add your own ideas to Professor Porsche's ideals.**

**Personalization options.**

No rules. No restrictions.  
Do you share that philosophy?  
We thought so. How you

customize your Cayman is  
well and truly in your own  
hands. And so it should be.

The following pages feature a wide  
selection of products, all arranged  
into convenient categories. For  
more information on the options  
featured in this catalog, please

contact your Authorized Porsche  
dealer. These are not the only  
ways to style your Cayman model  
to your personal preference. With  
the Porsche Exclusive range,

you can have your car prepared  
exactly the way you want it. Turn  
something special into something  
unique. Of course, you can  
always personalize your Porsche

at a later time with our Porsche  
Equipment range of accessories.

Porsche always strives for efficiency.  
Now that goes for getting the options you want, too.

**Introducing the Porsche Option Packages: our most popular options, grouped to offer you more Porsche, more efficiently than ever.**

	Cayman	Cayman S
<b>Convenience Package</b>		
<b>With this package of options, you'll add the tools to turn darkness into light, quiet the wind, sense the rain, and control the temperature.</b>		
• Bi-Xenon™ headlights with dynamic cornering lights	•	•
• Auto-dimming mirrors with integrated rain sensor	•	•
• Auto air conditioning	•	•
• Porsche Crest on headrests	•	•

	Cayman	Cayman S
<b>Infotainment Package</b>		
<b>From central management of information and navigation to audio precision, this package turns Cayman into a command center.</b>		
• PCM including navigation module	•	•
• Sound Package Plus	•*	
• Bose® Surround Sound system	•*	•
• XM® Satellite Radio	•	•

\*Infotainment package can be specified with either stereo: Sound Package Plus or Bose® Surround Sound system.  
• Package standard equipment

You've always been able to order any available Porsche option on an individual basis. And that's not going to change. Now we're also

offering select options as part of a series of packages. Our new Option Packages make it easier to option out your Porsche in the

most efficient manner and at a better cost to you, making it easier to build that Porsche you have always dreamed of.

	Cayman	Cayman S
<b>Design Package</b>		
<b>Bring out the essence of Cayman with this package of racing-inspired optional design elements.</b>		
• 19-inch Spyder wheel	•	•
• Wheels painted black	•	•
• Exterior mirrors painted black	•	•
• Sport tailpipes painted black	•	•
• Side air intakes, black	•	•
• Frame ventilation grille, black	•	•
• Trim panel, gear lever panel in black	•	•
• Model designation painted black	•	•

	Cayman	Cayman S
<b>Design Sport Package</b>		
<b>Transform your Cayman with the highest levels of aerodynamic design.</b>		
<b>Design Package plus the following:</b>		
• SportDesign Package	•	•
• Cayman Aerokit	•	•



Bi-Xenon™ headlights with dynamic cornering lights and LED daytime running lights

Exterior.	Cayman	Cayman S	Code	Page
<b>Option</b>				
• Metallic paint	○	○	Code	131
• Special colors	○	○	Code	131
• Color to sample	○	○	Code	
• Bi-Xenon™ headlights with dynamic cornering lights and LED daytime running lights	○	○	P75	63, 106
• Deletion of model designation	W	W	498	



Roof Transport System with roof box

Exterior.	Cayman	Cayman S	Code	Page
<b>Option</b>				
• ParkAssist (parking aid at rear)	○	○	635	81
• Cayman Aerokit	○	○	XAM	
• Rear wiper	○	○	425	81
• Auto-dimming interior/exterior mirrors with integrated rain sensor	○	○	P12	81
• Roof Transport System (basic load carrier)	○	○	549	85, 107
• Side stripes with model designation	○	○	CMX	

The vehicles illustrated in the chapter on personalization may include additional options not featured in this catalog. For information on these options, please consult your authorized Porsche dealer.  
 – not available ○ extra-cost option ● standard equipment W available at no extra cost



17-inch Boxster III wheel



18-inch Boxster S II wheel



19-inch Carrera Classic wheel



19-inch SportDesign wheel



19-inch Carrera Sport wheel



18-inch Cayman S II wheel



19-inch Carrera S II wheel



19-inch 911 Turbo wheel



19-inch 911 Turbo II wheel

**Engine, transmission, and chassis.**

Option			Code	Page
	Cayman	Cayman S		
• Porsche Doppelkupplung (PDK, 7-speed)	○	○	250	44
• Porsche Ceramic Composite Brakes (PCCB)	—	○	450	66
• Porsche Active Suspension Management (PASM) with ride height lowered by 0.39 of an inch (10 mm)	○	○	475	56
• Mechanically locking rear differential (only in conjunction with 18-inch or 19-inch wheels)	○	○	220	56
• Sport Chrono Package	○	○	639	58
• Sport Chrono Package Plus (only in conjunction with PCM)	○	○	640	59
• Sport exhaust system	○	○	XLF	40

The vehicles illustrated in the chapter on personalization may include additional options not featured in this catalog. For information on these options, please consult your authorized Porsche dealer.  
 — not available ○ extra-cost option ● standard equipment W available at no extra cost

**Wheels.**

Option			Code	Page
	Cayman	Cayman S		
• 17-inch Boxster III wheels	○	—	394	108
• 18-inch Cayman S II wheels	○	●	409	55, 108
• 18-inch Boxster S II wheels	○	○	408	108
• 19-inch Carrera S II wheels	○	○	419	108
• 19-inch Carrera Classic wheels	○	○	405	109
• 19-inch SportDesign wheels	○	○	407	109
• 19-inch Carrera Sport wheels <sup>1</sup>	○	○	XRR	109
• 19-inch 911 Turbo wheels	○	○	404	109
• 19-inch 911 Turbo II wheels	○	○	421	109
• Wheel centers with full-color Porsche Crest	○	○	446	

<sup>1</sup>Includes wheel centers with full-color Porsche Crest.



Roof liner in Alcantara®



Sport seat

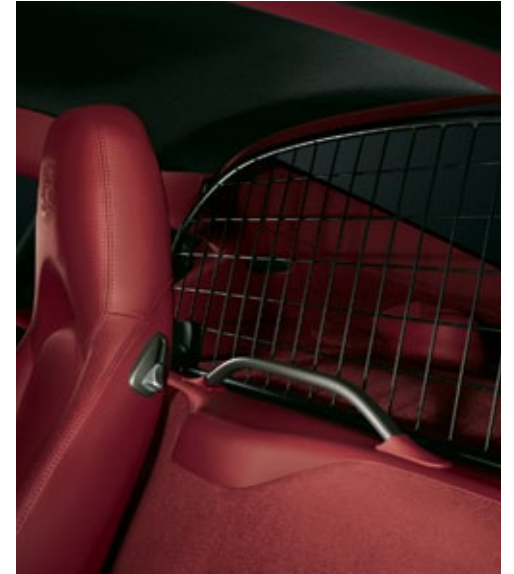

Luggage stop

**Interior.**

	Cayman	Cayman S		
Option			Code	Page
• InteriorDesign Package, painted	○	○	805	
• Automatic climate control	○	○	573	79
• Roof liner in Alcantara®	○	○	594	110

**Interior.**

	Cayman	Cayman S		
Option			Code	Page
• Power seats with driver memory	○	○	P15	78
• Sport seats	○	○	P77	78, 111
• Adaptive Sport Seats with driver memory	○	○	P01	78
• Sport bucket seats	○	○	P03	79
• Seat heating	○	○	342	79
• Seat ventilation (only in conjunction with seat heating)	○	○	541	79
• Heated steering wheel (only in conjunction with seat heating)	○	○	345	77
• Luggage stop	○	○	580	83, 111
• Fire extinguisher	○	○	509	

The vehicles illustrated in the chapter on personalization may include additional options not featured in this catalog. For information on these options, please consult your authorized Porsche dealer.  
 – not available ○ extra-cost option ● standard equipment W available at no extra cost



Soft ruffled leather seat



Three-spoke multifunction steering wheel



Three-spoke multifunction steering wheel in Aluminum-Look and personalization options from the Porsche Exclusive range

**Interior: leather and natural leather.**

	Cayman	Cayman S		
<b>Option</b>			<b>Code</b>	<b>Page</b>
• Partial Leather seats	○	○	946	
• Soft ruffled leather seats (only in conjunction with leather interior)	○	○	982	112
• Leather interior package (includes seats, dashboard upper/lower sections, and door panels in Smooth-Finish Leather)				
– in standard color	○	○	Code	
– in special color	○	○	Code	
– in two-tone combination	○	○	970	
– in natural leather	○	○	998	76, 77
– in color to sample	○	○	Code	
• Three-spoke multifunction steering wheel for PDK	○	○	844	77, 112
• Three-spoke sport steering wheel with gearshift paddles for PDK	○	○	840	

**Interior: Aluminum-Look/aluminum.**

	Cayman	Cayman S		
<b>Option</b>			<b>Code</b>	<b>Page</b>
• Three-spoke multifunction steering wheel in Aluminum-Look	○	○	XPU	113
• Gear and handbrake levers in Aluminum I	○	○	ECA	113
• PDK gear selector and handbrake lever in Aluminum	○	○	ECB	

The vehicles illustrated in the chapter on personalization may include additional options not featured in this catalog. For information on these options, please consult your authorized Porsche dealer.  
 – not available ○ extra-cost option ● standard equipment W available at no extra cost





Makassar interior package, three-spoke multifunction steering wheel in Makassar, and personalization options from the Porsche Exclusive range



Carbon Fiber interior package, three-spoke multifunction steering wheel in Carbon Fiber, and personalization options from the Porsche Exclusive range

**Interior: Makassar dark wood (satin-matte finish).**

	Cayman	Cayman S		
Option			Code	Page
• Makassar interior package <sup>1</sup>	<input type="radio"/>	<input type="radio"/>	801	114
• Three-spoke multifunction steering wheel in Makassar <sup>1</sup> for PDK	<input type="radio"/>	<input type="radio"/>	847	114
• Three-spoke multifunction steering wheel in Makassar <sup>1</sup>	<input type="radio"/>	<input type="radio"/>	451	

**Interior: Carbon Fiber.**

	Cayman	Cayman S		
Option			Code	Page
• Carbon Fiber interior package	<input type="radio"/>	<input type="radio"/>	803	115
• Three-spoke multifunction steering wheel in Carbon Fiber for PDK	<input type="radio"/>	<input type="radio"/>	845	115
• Three-spoke multifunction steering wheel in Carbon Fiber	<input type="radio"/>	<input type="radio"/>	453	

<sup>1</sup>Since wood is a natural product, there may be variations in color and grain.

The vehicles illustrated in the chapter on personalization may include additional options not featured in this catalog. For information on these options, please consult your authorized Porsche dealer.  
 – not available     extra-cost option     standard equipment     available at no extra cost



XM® Satellite Radio



Porsche Communication Management (PCM)

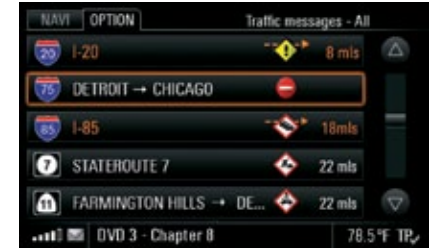

XM® NavTraffic®

**Audio and communication.**

	Cayman	Cayman S		
<b>Option</b>			<b>Code</b>	<b>Page</b>
• CDR-30 audio system <sup>1</sup>	•	•		86, 90, 92
• Integrated six-disc CD changer (for CDR-30) <sup>1</sup>	○	○	692	86, 90
• Sound Package Plus, including CD storage (for CDR-30 and PCM)	○	○	490	90
• Bose® Surround Sound system, including CD storage (for CDR-30 and PCM)	○	○	680	92
• Rod antenna XM® Satellite Radio (for CDR-30 and PCM)	W	W	461	

**Audio and communication.**

	Cayman	Cayman S		
<b>Option</b>			<b>Code</b>	<b>Page</b>
• PCM with navigation module <sup>1</sup>	○	○	P23	88
• Integrated six-disc CD/DVD changer (for PCM) <sup>1</sup>	○	○	693	88
• Electronic logbook (for PCM)	○	○	641	88
• XM® Satellite Radio	○	○	686	91

<sup>1</sup>May be incompatible with some copy-protected audio CDs/DVDs.  
 The vehicles illustrated in the chapter on personalization may include additional options not featured in this catalog.  
 For information on these options, please consult your authorized Porsche dealer.  
 – not available ○ extra-cost option ● standard equipment W available at no extra cost



## Porsche Exclusive

### State of the art. And to your specification.

With the range of options featured in this catalog, you can make your Porsche even more special. Introducing Porsche Exclusive. Have your vehicle individually and exclusively tailored to your wishes, even

before it leaves the factory. Aesthetically and technically, inside and outside, using fine materials and with customary Porsche quality. Our overriding principle? Uniquely handcrafted to your taste. You will find a wide range of design options in the separate Porsche Exclusive Cayman catalog.

Your Porsche dealer will be happy to answer any questions you may have.

Please note that delivery times may be extended for certain Porsche Exclusive equipment.

## Porsche Tourist Delivery

### You won't be able to sleep the night before. The night after, you won't want to.

Many of our customers dream of collecting their new Porsche in person. They want to be there when the car of their dreams leaves the factory. This way, they can be the first to take their Porsche to its rightful place: on the road.

Today, all Porsche engines are constructed here in our main factory in Zuffenhausen, where the legendary 356 was built. You can collect your Cayman from here. There's no need to rush just yet. Take your time and make the

factory tour one of the highlights of your visit. See Porsche production processes in action for yourself, from engine assembly and the preparation of upholstery to final installation. Experience is one of the key moments in the construction of any car: the "marriage" of engine/chassis and body. The factory tour is one of our oldest traditions and is always conducted by a Porsche enthusiast with extensive knowledge of the marque.

While visiting Zuffenhausen, stop by the Porsche Museum. Here, you'll find an impressive range of exhibits, including legendary Porsche models that have made

key contributions to the Porsche success story. Awaiting you in Leipzig are an impressive car exhibition and an exciting film presentation about the fascinating world of Porsche.

### The moment you've been waiting for.

The highlight of your visit will undoubtedly be the delivery of your Porsche—handed over by specialists who know it inside and out. They will take their time to explain everything you need to know about your new car and all its technical features.

Then you'll finally experience what it means to own a Porsche.



Vehicle handover in Zuffenhausen



### Porsche Tourist Delivery

Imagine touring the original factory and then being handed the keys for an even more gratifying opportunity: touring Europe in your brand-new Porsche. What happens next is up to you. Contact your local Porsche dealer for more information.

### Porsche Roadside Assistance

Your ownership experience is enhanced with complimentary enrollment in the Porsche 24-Hour Roadside Assistance program. It includes coverage 24 hours a day, 365 days a year, for the duration of your warranty. Contact your Porsche dealer for specifics.

### Porsche Financial Services

Competitive, convenient, and carefully crafted financing options can be customized to meet your needs. Ask your certified Porsche Sales Consultant for details.

### Porsche Exclusive

Realize your vision of the perfect Porsche with our factory customization program. From styling enhancements to performance upgrades, all modifications are uniquely handcrafted for your Porsche.

### Porsche Tequipment

Personalize your Porsche at any time after purchase with the Tequipment range of approved accessories. Designed exclusively for your Porsche, every product is fully guaranteed.

### Porsche Design Driver's Selection

Our distinctive collection of clothing and accessories combines timeless elegance with unmistakable quality. Visit your local Porsche dealer or shop online at [porscheusa.com/shop](http://porscheusa.com/shop).

## Service

### Porsche Approved Pre-Owned

Only the best Porsche cars earn the right to be called "Certified." A meticulous 111-point inspection, a 2-year or 50,000-mile Limited Warranty, and 24-Hour Roadside Assistance make this program one of a kind. Contact your Porsche dealer for details.

### Porsche Classic

Your specialist source for genuine Porsche parts and technical documentation, as well as servicing, repair, and restoration for all types of classic Porsches. For more information, visit [porscheusa.com/classic](http://porscheusa.com/classic).

### Christophorus

Our bimonthly magazine for Porsche owners is packed with news, articles, and exclusive interviews covering every aspect of Porsche automobiles and the Porsche lifestyle.

### Porsche Clubs

With more than 120,000 members worldwide in 60 countries, know you are not alone in your passion for Porsche. Learn more about the brand and meet other Porsche enthusiasts just like yourself. Visit [porscheusa.com](http://porscheusa.com) for more information.

### Porsche Driving Experience

**1. Porsche Travel Club.** Exclusive driving holidays and incentive ideas combining luxury and adventure, worldwide. To find out more, contact us by e-mail at [travel.club@porsche.us](mailto:travel.club@porsche.us).

### 2. Porsche Sport Driving School.

Develop your skill and explore your Porsche with the Porsche Sport Driving School. Learn firsthand from famed Porsche Racing drivers while they teach you at a world-class racing facility. Visit [porschedriving.com](http://porschedriving.com) for more information.

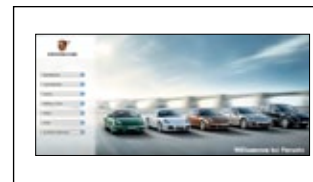

### Porsche Online

For all the latest news and information from Porsche, go to [porscheusa.com](http://porscheusa.com).

Follow us on:



Ask your Porsche dealer for the latest brochures from Porsche Exclusive, Porsche Tequipment, Porsche Design Driver's Selection, and the Porsche Driving Experience.



## Summary

The Cayman models. They're sophisticated, mature—but far from conformist. At the core: a resolute drive for power. At the fore: a character that's simply

unyielding. You can see it; you can feel it. With every rev. With every inch of road. The Cayman: an uncompromising declaration of individuality.

# Technical data

	Cayman	Cayman S
<b>Engine</b>		
Type	Horizontally opposed cylinders	Horizontally opposed cylinders
Installation	Mid-mounted	Mid-mounted
Cylinders	6	6
Displacement	2.9 liters	3.4 liters
Max. power (DIN) at rpm	265 hp 7200 rpm	320 hp 7200 rpm
Max. torque at rpm	221 lb.-ft. 4400–6000 rpm	273 lb.-ft. 4750 rpm
Compression ratio	11.5:1	12.5:1
<b>Transmission</b>		
Layout	Rear-wheel drive	Rear-wheel drive
Manual gearbox	6-speed	6-speed
PDK (optional)	7-speed	7-speed
<b>Chassis</b>		
Front axle	Lightweight spring-strut suspension	Lightweight spring-strut suspension
Rear axle	Lightweight spring-strut suspension	Lightweight spring-strut suspension
Steering	Power-assist (hydraulic), with variable-steering ratio	Power-assist (hydraulic), with variable-steering ratio
Turning circle	36.4 ft. (11.1 m)	36.4 ft. (11.1 m)
Brakes	Four-piston, aluminum monobloc fixed calipers front and rear, internally vented and cross-drilled discs	Four-piston, aluminum monobloc fixed calipers front and rear, internally vented and cross-drilled discs
Vehicle stability system	PSM (with ABS 8.0)	PSM (with ABS 8.0)
Wheels	Front: 7J x 17 Rear: 8.5J x 17	Front: 8J x 18 Rear: 9J x 18
Tires	Front: 205/55 ZR 17 Rear: 235/50 ZR 17	Front: 235/40 ZR 18 Rear: 265/40 ZR 18

	Cayman	Cayman S
<b>Weights</b>		
	Manual/PDK	Manual/PDK
Curb weight	2,932 lbs./2,998 lbs.	2,976 lbs./3,031 lbs.
<b>Performance</b>		
	Manual/PDK (Sport Plus) <sup>1</sup>	Manual/PDK (Sport Plus) <sup>1</sup>
Top track speed	164 mph/163 mph	172 mph/170 mph
0–60 mph	5.5 secs/5.4 secs/5.2 secs <sup>1</sup>	4.9 secs/4.8 secs/4.6 secs <sup>1</sup>
0–99 mph	13.4 secs/13.2 secs/12.9 secs <sup>1</sup>	11.4 secs/11.2 secs/10.9 secs <sup>1</sup>
<b>Fuel consumption/emissions</b>		
	Manual/PDK	Manual/PDK
City (mpg)	19/20	19/20
Highway (mpg)	27/29	26/29
<b>Dimensions/aerodynamics</b>		
Length	172.3 inches (4,377 mm)	172.3 inches (4,377 mm)
Width	70.9 inches (1,801 mm)	70.9 inches (1,801 mm)
Height	51.3 inches (1,304 mm)	51.4 inches (1,306 mm)
Wheelbase	95.1 inches (2,415 mm)	95.1 inches (2,415 mm)
Cargo volume	14.5 cu. ft. (410.6 liters)	14.5 cu. ft. (410.6 liters)
Fuel tank capacity	16.9 gal.	16.9 gal.
Drag coefficient	0.29/0.29	0.29/0.30

<sup>1</sup>With Sport Plus button in conjunction with the optional Sport Chrono Package or Sport Chrono Package Plus.

# Index

Term	Page										
<b>A</b>											
Active safety	62										
Airbags	70										
Air-conditioning system	79										
Anti-theft protection	71										
Audio interface, universal	90										
<b>B</b>											
Bose® Surround Sound system	92										
Braking system	65										
<b>C</b>											
CD changer	90										
CDR-30 audio system	86, 90, 92										
Chassis	50										
Child seats	71										
Colors	128										
Cornering lights, dynamic	63										
<b>D</b>											
Direct Fuel Injection (DFI)	30										
Dry-sump lubrication, integrated	34										
<b>E</b>											
Engine cooling	36										
Engine, flat-six	28										
Engine management	36										
Environment	94										
Exclusive	118										
Exhaust emissions control	96										
Exhaust system	40										
<b>F</b>											
Fuel	99										
Fuel system	99										
<b>G</b>											
Garage door opener (HomeLink®)	80										
<b>H</b>											
Headlight-cleaning system	63										
Headlights, Bi-Xenon™	63										
Heated seats	79										
Heated steering wheel	77										
Hill Start Assist	49										
HomeLink® (programmable garage door opener)	80										
<b>I</b>											
Ignition	40										
Instruments	76										
<b>L</b>											
LED daytime running lights	63										
Logbook, electronic	88										
Luggage compartment, front	82										
Luggage space, rear	82										
<b>M</b>											
Maintenance	99										
Maintenance requirements	41										
Manual gearbox	49										
Mobile phone	90										
Mobile phone preparation	90										
<b>N</b>											
Navigation module	88										
Noise	99										
<b>O</b>											
Oil supply	34										
Onboard computer, integrated	76										
<b>P</b>											
ParkAssist	81										
Passive safety	69										
Personalization options	100										
Porsche Active Suspension Management (PASM)	56										
Porsche Ceramic Composite Brakes (PCCB)	66										
Porsche Communication Management (PCM)	88										
Porsche Doppelkupplung (PDK)	44										
Porsche Side Impact Protection (POSIP)	70										
Porsche Stability Management (PSM)	68										
Porsche Tourist Delivery	119										
<b>R</b>											
Rear differential, mechanically locking	56										
Rear wiper	81										
Recycling	99										
Resonance intake manifold	39										
Roof Transport System	85										
<b>S</b>											
Safety, active	62										
Safety, passive	69										
Seats, power	78										
Seat ventilation	79										
Service	120										
Side windows, water-repellent	80										
Sound Package Plus	90										
Sport bucket seats	79										
Sport Chrono Package	58										
Sport Chrono Package Plus	59										
Sport exhaust system	40										
Sport seats	78										
Sport Seats, Adaptive	78										
Standard seats	78										
Steering	54										
Steering wheels	77										
Storage compartments	84										
<b>T</b>											
Technical data	124										
Tire Pressure Monitoring System (TPMS)	55										
Transport concept	82										
<b>V</b>											
VarioCam Plus	39										
Voice-control system	90										
<b>W</b>											
“Welcome Home” lighting	80										
Wheels	55										
Windshield wipers	80										

## Colors.

When it comes to individual style, one of the most important considerations is your choice of color.

Available for selection are four solid colors, seven metallic colors, five special colors, and 10 interior colors, including a two-tone leather

package—a combination of Black and Stone Grey. Of course, you can choose to have your Cayman or Cayman S finished in virtually any other color of your choice. It's just a case of what takes your fancy. For further information, please refer to the Porsche Exclusive Cayman catalog.

Using the Porsche Car Configurator at [porscheusa.com](http://porscheusa.com), you can transform your ideas into reality. Here, you can design your very own Cayman or Cayman S from the ground up. The choice of color or additional equipment, as always, is up to you.



## Standard interior colors.

### Alcantara®/leatherette/ leather/soft-touch paint.



Black<sup>1</sup>



Stone Grey<sup>1</sup>

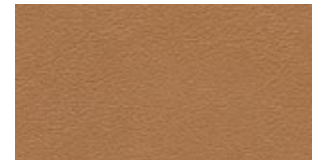

Sand Beige<sup>1</sup>



Sea Blue<sup>1</sup>

### Carpet.



Black



Stone Grey



Sand Beige



Sea Blue

### Roof liner.



Black



Volcano Grey<sup>4</sup>

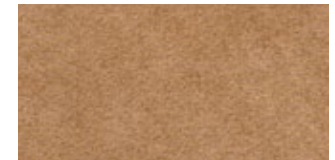

Sand Beige



Volcano Grey<sup>4</sup>

Footnotes apply to pages 129 and 130.

<sup>1</sup>Soft-touch paint in interior color; sun visors and inner door-entry guards with film finish in interior color.

<sup>2</sup>Interior in special color, natural leather interior in Brown and Carrera Red: soft-touch paint in interior color; sun visors and door-entry guards with black film finish.

<sup>3</sup>Natural leather interior in Dark Grey: soft-touch paint in black; sun visors and inner door-entry guards with black film finish.

<sup>4</sup>In conjunction with Alcantara®: roof liner in Steel Grey.



**Special interior colors.**

**Natural leather/  
leather/soft-touch paint.**



Two-tone (Black and Stone Grey)



Natural leather in Carrera Red<sup>2</sup>

**Carpet.**



Stone Grey



Carrera Red

**Roof liner.**



Volcano Grey<sup>4</sup>



Black

**Solid exterior colors.**



Black



Guards Red

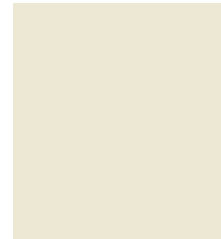

Carrara White



Speed Yellow<sup>1</sup>

**Metallic exterior colors.**



Basalt Black Metallic

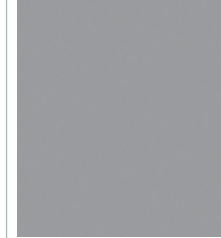

Platinum Silver Metallic



Dark Blue Metallic

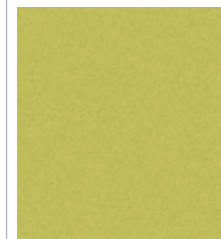

Peridot Metallic<sup>1</sup>



Macadamia Metallic

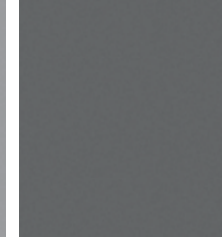

Meteor Grey Metallic

**Special exterior colors.**

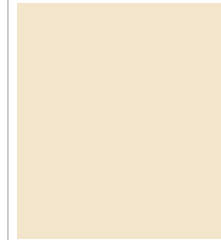

Cream White<sup>1</sup>



GT Silver Metallic

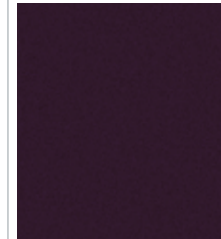

Amethyst Metallic<sup>1</sup>

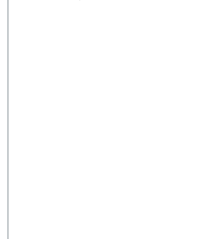

Ruby Red Metallic



Porsche Racing Green  
Metallic<sup>1</sup>

<sup>1</sup>Available until 07/11.